

Model 640 Series Indicators

Model 640XL



Model 640

Model 640M



User Instructions

NORTH AMERICA

© Avery Weigh-Tronix group of companies 2009. All rights reserved.

No part of this publication may be reproduced, stored in an electronic retrieval system, or transmitted in any form or by any means, electronic, mechanical, photocopying, recording or otherwise without the prior written consent of the copyright owner, or as permitted by law or under license. Full acknowledgment of the source must be given. Avery Weigh-Tronix is a registered trade mark of the Avery Weigh-Tronix group of companies. This publication was correct at the time of going to print however, Avery Weigh-Tronix reserves the right to alter without notice the specification, design, price or conditions of supply of any product or service at any time.

All third party brands and product names used within this document are trademarks or registered trademarks of their respective holders.

Table of Contents

	<i>page</i>
Chapter 1 General Information and Warnings	5
About this manual	5
Installation	6
Safe handling of equipment with batteries	6
Routine maintenance	6
Cleaning the machine	7
Training	7
Sharp objects	7
FCC and EMC declarations of compliance	8
Chapter 2 Introduction	10
Front Panel	10
Key Descriptions	11
Annunciators	11
Display Messages	12
Numeric Entry Procedure	13
Getting Started	13
Mounting the Model 640	14
Cable Connections	15
Model 640 and 640XL Bottom Panels	15
Model 640M Lower Connector Options	16
Connector Pin Descriptions	17
Chapter 3 User Menu	18
Editing The A-LIST	20
Accessing the Accumulator Statistics	21
Clearing Accumulators	22
Viewing or Changing the Time	23
Viewing or Changing the Date	24
Entering / Viewing the Audible Keypad Setting	24
Entering / Viewing the Sleep Parameter	25
Setting the Backlight Operation	25
Entering / Viewing the Language Selection (Not currently functioning)	27
Printing a Configuration Report	27
Chapter 4 Weighing Procedures	29
Simple Weighing	29
Gross/Tare/Net (GTN) Weighing (single tare example)	29
Loading or Unloading Consecutive Net Amounts	30
Loading/Unloading Net Amounts (XM64 Transmitter)	30
Using Memory Channels to Accumulate	31
Editing Memory Channel List	31
Accessing Memory Channels	32
Using Memory Channels to Accumulate	32
Clearing the Accumulators	32
To Clear a Specific Memory Channel	34
To Print an Individual Memory Channel	34
To Print All Memory Channels	34
Manual Hold for Mobile Systems	37
Using Hold Mode for Maintaining Weight Overnight	37
Animal Weighing Using AUTO-LOC Feature	37
How to Set Up AUTO-LOC	38

Weighing Individual Animals with Standard Mode AUTO-LOC	40
Weighing Individual Animals with Advanced Mode AUTO-LOC	40
Printing	42
Chapter 5 Test Menu	45
Test Menu Summary	45
Access the Test Menu	46
Test Menu Items	46
VOLTS (Input voltage)	46
LCD (LCD Display test)	47
KEYPAD (Keypad test)	47
A/D (View /Test A to D counts)	48
SERIAL (Testing Serial Ports)	48
INPUT (Testing the Input)	49
SOFT (Software PN, version and revision)	49
Chapter 6 Remote Displays & XM64 Remote Transmitter	51
Remote Displays	51
XM64 Wireless Remote Transmitter	52
Chapter 7 Specifications	53
Chapter 8 Appendix: Quick Programming Guide	55
How to Verify the Scale is Weighing Properly	55
To Access the Setup Menu (640)	55
(CONFIG) Finding and Entering a Configuration Code Number	55
Configuration Code Numbers for Common applications:	58
Configuring the Model 640 for Other Brand Weigh Bars and Loadcells	58
Viewing/Entering a Custom Calibration Number	59
How to Configure Filtering	60
Chapter 9 Appendix: Troubleshooting	62
Power ON Problems	62
Indicator +/- RANGE Problem	63
Indicator Over or Under Capacity Problem	64
Inaccurate Weight Readings	64
Drifting Weight Readings	64
Loss of Data: Time & Date or Memory channels	65
How to Get Service Repairs	65

1 General Information and Warnings

1.1 About this manual

This manual is divided into chapters by the chapter number and the large text at the top of a page. Subsections are labeled as shown by the 1 and 1.1 headings shown above. The names of the chapter and the next subsection level appear at the top of alternating pages of the manual to remind you of where you are in the manual. The manual name and page numbers appear at the bottom of the pages.

Text conventions

Key names are shown in **bold** and reflect the case of the key being described. This applies to hard keys and onscreen or soft keys.

Displayed messages appear in ***bold italic*** type and reflect the case of the displayed message.

Special messages

There are five types of special text messages, NOTE, CAUTION, WARNING, DANGER, and ELECTRICAL HAZARD. Each will appear as illustrated below:



NOTE: This contains extra information on a concept or process.



CAUTION: This may cause damage to the product or data loss.



WARNING: This could result in injury or death



DANGER: THIS WILL RESULT IN INJURY OR DEATH



ELECTRICAL DANGER: THIS WILL RESULT IN INJURY OR DEATH.

1.2 Installation



DANGER: RISK OF ELECTRICAL SHOCK. NO USER SERVICEABLE PARTS. REFER TO QUALIFIED SERVICE PERSONNEL FOR SERVICE.

1.2.1 Safe handling of equipment with batteries



CAUTION: Danger of explosion if battery is incorrectly replaced. Replace only with the same or equivalent type recommended by the manufacturer. Dispose of used batteries according to the manufacturer's instructions.

ATTENTION: Il y a danger d'explosion s'il y a remplacement incorrect de la batterie, remplacer uniquement avec une batterie du même type ou d'un type équivalent recommandé par le constructeur. Mettre au rebut les batteries usagées conformément aux instructions du fabricant.

1.3 Routine maintenance



IMPORTANT: This equipment must be routinely checked for proper operation and calibration. Application and usage will determine the frequency of calibration required for safe operation.

Always turn off the machine and isolate from the power supply before starting any routine maintenance to avoid the possibility of electric shock.

Make sure that it is placed securely on a flat and level surface.

1.4 Cleaning the machine

Table 1.1 Cleaning DOs and DON'Ts



DO	DO NOT
Wipe down the outside of standard products with a clean cloth, moistened with water and a small amount of mild detergent	Attempt to clean the inside of the machine
	Use harsh abrasives, solvents, scouring cleaners or alkaline cleaning solutions
Spray the cloth when using a proprietary cleaning fluid	Spray any liquid directly on to the display windows

1.5 Training

Do not attempt to operate or complete any procedure on a machine unless you have received the appropriate training or read the instruction books.

To avoid the risk of RSI (Repetitive Strain Injury), place the machine on a surface which is ergonomically satisfactory to the user. Take frequent breaks during prolonged usage.

1.6 Sharp objects

Do not use sharp objects such as screwdrivers or long fingernails to operate the keys.

1.7 FCC and EMC declarations of compliance

United States

Table 1.2

This equipment has been tested and found to comply with the limits for a Class A digital device, pursuant to Part 15 of the FCC Rules. These limits are designed to provide reasonable protection against harmful interference when the equipment is operated in a commercial environment. This equipment generates, uses, and can radiate radio frequency energy and, if not installed and used in accordance with the instruction manual, may cause harmful interference to radio communications. Operation of this equipment in a residential area is likely to cause harmful interference in which case the user will be required to correct the interference at his own expense.

Canada

Table 1.3

This digital apparatus does not exceed the Class A limits for radio noise emissions from digital apparatus set out in the Radio Interference Regulations of the Canadian Department of Communications.

Le présent appareil numérique n'émet pas de bruits radioélectriques dépassant les limites applicables aux appareils numériques de la Classe A prescrites dans le Règlement sur le brouillage radioélectrique édicté par le ministère des Communications du Canada.

European Countries

Table 1.4

WARNING: This is a Class A product. In a domestic environment, this product may cause radio interference in which the user may be required to take adequate measures.

Avery Weigh-Tronix**Avery Weigh-Tronix,
Foundry Lane, Smethwick, West Midlands B66 2LP, England.**

	Declaration of Conformity	Konformitätserklärung
	Verklaring van overeenstemming	Dichiarazione di Conformità
	Déclaration de Conformité	Declaración de Conformidad

Manufacturer	Avery Weigh-Tronix
Type	640/640M/640XL RD40/RD40XL/ RD40RF
corresponds to the requirements of the following EC directives:	
EMC Directive	89/336/EEC
Low Voltage Directive	73/23/EEC
The applicable harmonised standards are:	
EN 60950-1:2002	EN 61000-6-1:2001
EN 61000-6-3:2001	
Avery Weigh-Tronix, LLC Reg. Office: Foundry Lane, Smethwick, West Midlands B66 2LP, England. Registered in England No: 595129	

Fabrikant	Avery Weigh-Tronix
Type	640/640M/640XL RD40/RD40XL/ RD40RF
is in overeenstemming met de voorschriften van de volgende EG richtlijnen:	
EMC Richtlijn	89/336/EEG
Laagspanningsrichtlijn	73/23/EEG
Toegepaste geharmoniseerde normen:	
EN 60950-1:2002	EN 61000-6-1:2001
EN 61000-6-3:2001	
Avery Weigh-Tronix, LLC Vestigingsadres: Foundry Lane, Smethwick, West Midlands B66 2LP, England. Geregistreerd in Engeland nr: 595129	

Fabricant	Avery Weigh-Tronix
Type	640/640M/640XL RD40/RD40XL/ RD40RF
correspond aux exigences des directives CE suivantes :	
Directive CEM	89/336/CEE
Directive Basse Tension	73/23/CEE
Les normes harmonisées applicables sont :	
EN 60950-1:2002	EN 61000-6-1:2001
EN 61000-6-3:2001	
Avery Weigh-Tronix, LLC Siège social : Foundry Lane, Smethwick, West Midlands B66 2LP, England. Société immatriculée en Angleterre sous le No : 595129	

Hersteller	Avery Weigh-Tronix
Typ	640/640M/640XL RD40/RD40XL/ RD40RF
entspricht den Anforderungen folgender EG-Richtlinien:	
EMV-Richtlinie	89/336/EWG
Niederspannungs-Richtlinie	73/23/EWG
Die angewendeten harmonisierten Normen sind:	
EN 60950-1:2002	EN 61000-6-1:2001
EN 61000-6-3:2001	
Avery Weigh-Tronix, LLC Geschäftssitz: Foundry Lane, Smethwick, West Midlands B66 2LP, England. Eingetragen in England unter Nr. 595129	

Produttore	Avery Weigh-Tronix
Modello	640/640M/640XL RD40/RD40XL/ RD40RF
è conforme alle caratteristiche previste dalle seguenti direttive CE:	
Normativa EMC	89/336/CEE
Normativa per la bassa tensione	73/23/CEE
Le norme standard armonizzate e nazionali applicate sono:	
EN 60950-1:2002	EN 61000-6-1:2001
EN 61000-6-3:2001	
Avery Weigh-Tronix, LLC Sede legale: Foundry Lane, Smethwick, West Midlands B66 2LP, England. Depositata in Gran Bretagna al numero di registro: 595129	

Fabricante	Avery Weigh-Tronix
Tipo	640/640M/640XL RD40/RD40XL/ RD40RF
conforme a las exigencias de las siguientes directivas CE:	
Directiva CME	89/336/CEE
Directiva de baja tensión	73/23/CEE
Las normas armonizadas en vigor son:	
EN 60950-1:2002	EN 61000-6-1:2001
EN 61000-6-3:2001	
Avery Weigh-Tronix, LLC Oficina de matriculación: Foundry Lane, Smethwick, West Midlands B66 2LP, England. Registrada en Inglaterra No: 595129	

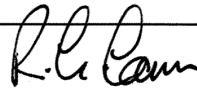
Signature/Name Handtekening/Naam Signature/Nom Unterschrift/Name Firma/Nome Firma/Nombre	 R Cann Director of R&D Worldwide	Authorised signatory for Avery Weigh-Tronix Namens van Avery Weigh-Tronix Signataire autorisé d'Avery Weigh-Tronix Unterschriftsberechtigter für Avery Weigh-Tronix Firmatario autorizzato per Avery Weigh-Tronix Firmante autorizado para Avery Weigh-Tronix	Date Datum Date Datum Data Fecha
		19.05.06	

2 Introduction

This manual covers the information you need to operate your Avery Weigh-Tronix Model 640 indicator and remote display products.



Included in this manual are the Model 640, 640XL, 640M indicators and the RD40XL, RD40, and RD40RF remote displays.

2.1 Front Panel

The Model 640 indicator face is shown in Figure 2.1.



Figure 2.1 Front panel

2.1.1 Key Descriptions



Key names will appear as bold, upper case words in this manual. Examples: **TARE**, **G/N**, etc.

Annunciators will appear as italic words. Examples: *G/N*, *Lb*, etc.

Displayed messages will appear as bold, italic words. Examples: ***HELLO***, ***LO-BAT***, etc.

There are a total of 8 keys. All keys except the **ON/OFF** will have audible feedback with low, medium, or high volume settings.

ON/OFF	Press to turn the unit On/Off
TARE	Press to tare the weight on the scale
ZERO/CLEAR	Press to zero G/N weight. It also is used to clear memory channels.
G/N	Press to toggle between gross and net weight
HOLD/MENU	Press this key to hold a displayed weight. Press again to release the hold mode. The weight is retained in memory in case the unit is turned off. When powered up again the weight reading will still be displayed. This key is also used to move to the right in the menu structure. Use this key to also move the numeric entry cursor one space to the right. This will be explained in the <i>User Menu on page 18</i> of this manual.
PRINT/SELECT	Press this key to send data to an attached data collection device, printer, TDM or computer. This key is also used to move down in the menu structure.
RM	Press this key to access a memory channel, so the indicator is ready for accumulations into that channel. Also, use this key to increment numbers during the numeric entry procedure.
M+	Press this key to accumulate weights. Also, use this key to decrement numbers during the numeric entry procedure.
SERVICE	Press this key if you need contact information for your scale dealer. A key sticker will be placed in the location shown in Figure 2.1 if contact information was programmed by the dealer.

2.1.2 Annunciators

The Model 640 uses six triangle annunciators for Lb, kg, G/N, Net, Auto and Motion.

G/N	Indicates the unit is in the gross/net weighing mode.
NET	Indicates the unit is in the net weighing mode.
MOTION	Displayed when there is scale motion. This is based off the stability window parameters. See the <i>Service Manual</i> .
Lb	Indicates the unit is weighing in pounds.

AUTO	Displayed if the unit is programmed for AUTO-LOC. AUTO-LOC is used in animal weighing applications. Reference <i>Animal Weighing Using AUTO-LOC Feature</i> on page 37.
Kg	Indicates the unit is weighing in kilograms.

2.2 Display Messages

Following are the messages that may appear on the display and what they mean:

Message	Meaning
HELLO	Message displayed on power-up sequence for 3 seconds
-----	UPPER DASHES, Indicator is in a state of overcapacity, or analog input is too high.
-----	LOWER DASHES, Indicator is in a state of undercapacity, or analog input is too low.
-----	MIDDLE DASHES, This means the 640 is setup in Remote Mode. Call support to change setup to perform as a scale.
NO TARE	Displayed when you press the G/N key and there is no tare weight established.
PRINT	Indicator is transmitting data. Appears after pressing the print key for a second.
LO-BAT	Alternates on the display between current mode and LO-BAT when input voltage is between 9-10 volts.
HOLD	Used when moving a portable system.
L XXXX	XXXX = weigh value Displayed when the indicator is in AUTO-LOC mode and has locked on a weight.
+RANGE	Displayed when weight input exceeds 8 mV/V.
-RANGE	Displayed when weight input exceeds -8 mV/V.
SHTDWN	Is shown on the display prior to shutting the indicator off after the sleep timer has expired, or when you press the ON/OFF key. (10 seconds before sleep timer shutdown the alarm beeps several times).
CAN'T	Displayed when attempting to access too large of a numeric entry OR memory channel number greater than 100 OR if trying to zero in net mode.
MAINT	Maintenance required. A timer was set by the dealer as a reminder to perform maintenance.

2.3 Numeric Entry Procedure

Anytime you need to enter numeric values, use the keys as described below. The note below will appear throughout areas of the manual to remind you of the key presses needed to enter numbers.

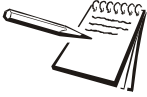

Numeric Entry Procedure



Press this key to enter a value on the screen and increment the value being entered.



Press this key to decrement the numeric value being entered.



Press this key to move the numeric entry cursor one position to the right.

EXAMPLE: To enter the number 5230:

1. At the data entry screen, press the **RM** key several times until...
 5 is displayed
2. Press the **HOLD/MENU** key and...
 5_ is displayed
3. Press the **RM** key several times until...
 52 is displayed.
4. Repeat process until...
 5230 is shown.

2.4 Getting Started

Before using your new Model 640 indicator:

- Please verify that everything has been properly connected. Reference *Cable Connections* on [page 15](#)
 - If you are mounting the indicator, see the next section: *Mounting the Model 640*.
 - Check the scale system to ensure proper units are set (lb, kg)
 - Verify the system is weighing properly. Do this by following these steps:
1. In the gross weighing mode, zero the indicator by pressing the **ZERO/CLEAR** key

- Stand on the scale and note the scale reading.

If the weight reading is correct, your system is working properly and you can continue with operation of the system.

If the weight reading is not correct, read through *Appendix: Quick Programming Guide* on page 55. This will tell you how to access the SETUP menu to change the Configuration Code Number (CCN). This should get your system up and running properly. If you have further problems, call your local dealer or Avery Weigh-Tronix.

2.5 Mounting the Model 640

The Model 640 mounts on a quick-detach bracket. Weld or bolt the quick-detach bracket into place, as follows:

- Choose a mounting location that is
 - convenient for operation of the indicator, and
 - protected from moving parts or from other moving machinery.
- Hold the indicator at the proposed mounting location, and verify that the display is legible and the controls accessible.
- Positioning the quick-detach bracket with the wider end at the top, mark the desired mounting location. If bolting, use the quick-detach bracket as a template and mark and drill holes.
- Weld or bolt the quick-detach bracket at the appropriate location. If bolting, use double nuts or self-locking nuts to protect both indicator and machinery.
- Insert the indicator bracket into the quick-detach bracket and push it down into place.
- For mobile applications, wrap and twist a strong wire around the indicator bracket and the quick-detach bracket, through the slotted hole provided, to stabilize the mounting. See the illustration below.

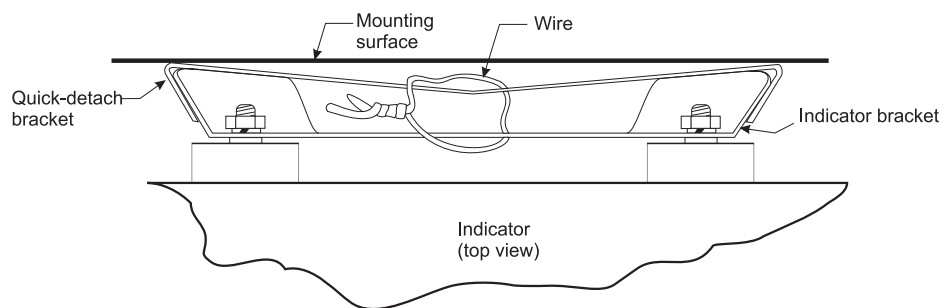

2.6 Cable Connections

Below are illustrations to help you make the proper connections to the different versions of the Model 640.

2.6.1 Model 640 and 640XL Bottom Panels

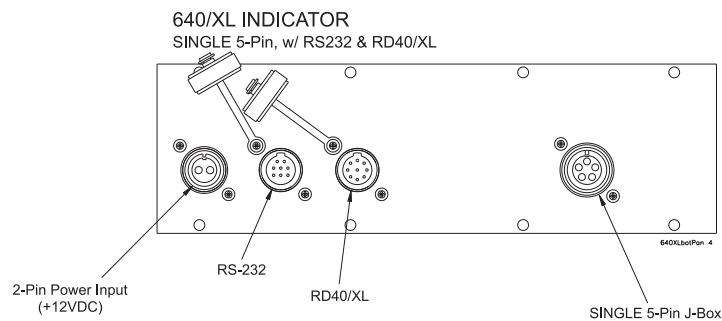
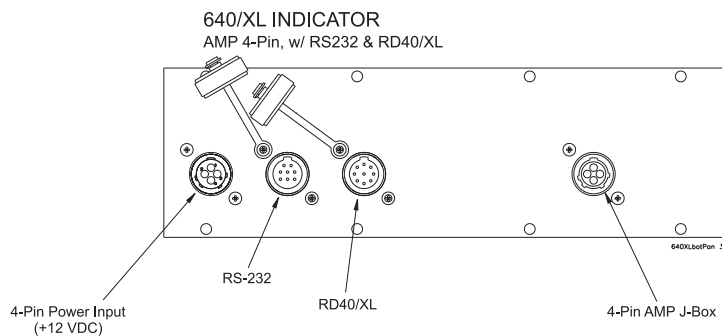
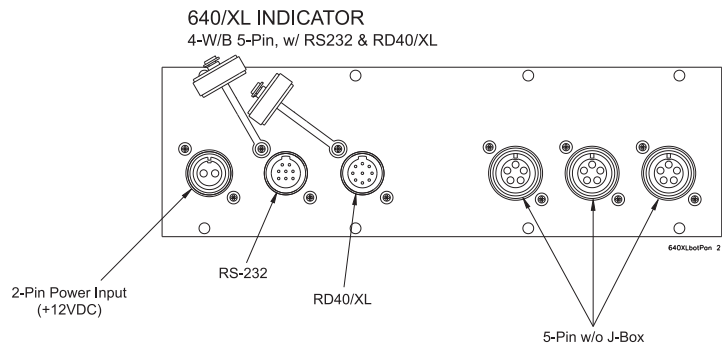
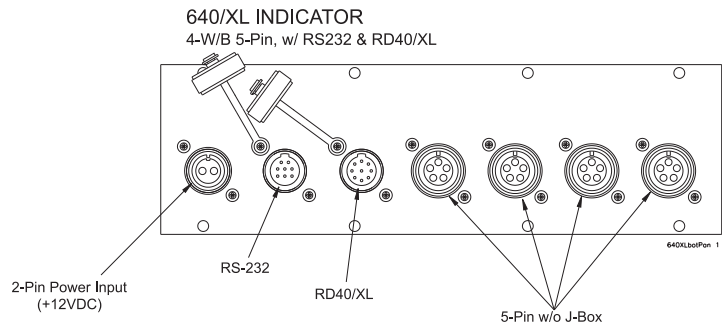

2.6.2 Model 640M Lower Connector Options

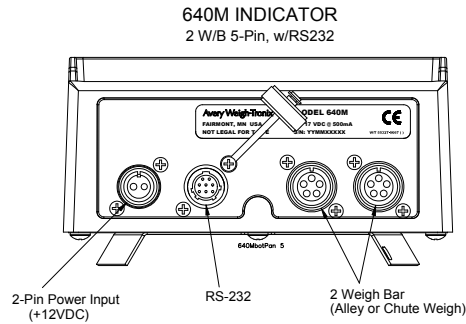
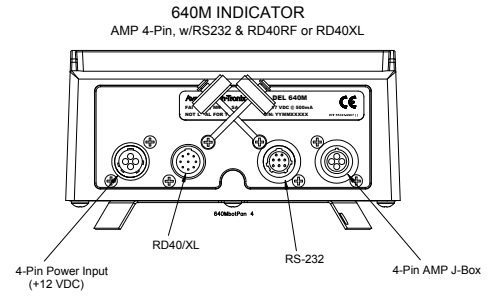
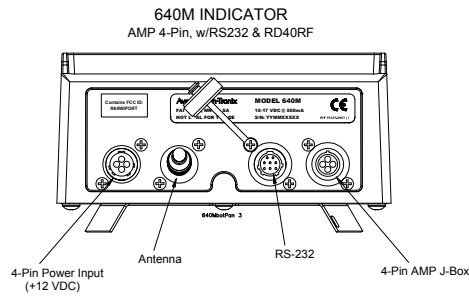
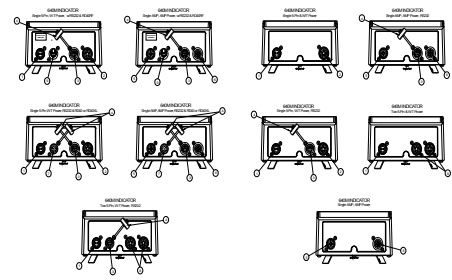
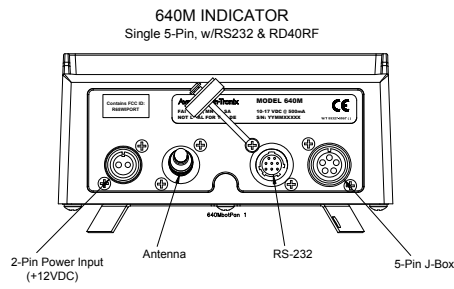

2.6.3 Connector Pin Descriptions

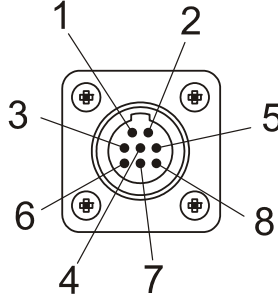
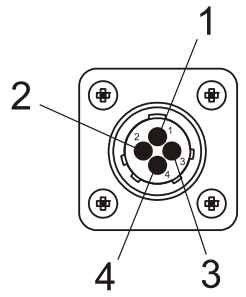
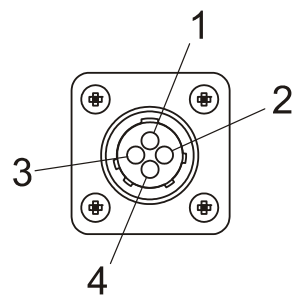
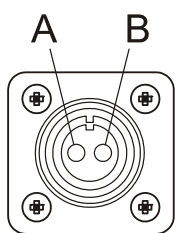
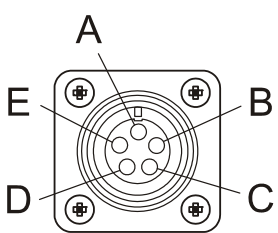
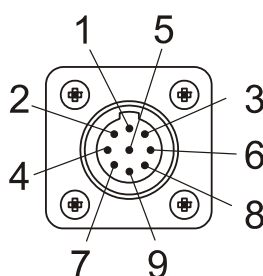
<p>RS-232 Port</p>  <p>Outside view (Male)</p> <table border="1" data-bbox="519 315 779 630"> <thead> <tr> <th>Pin</th> <th>Description</th> </tr> </thead> <tbody> <tr><td>1</td><td>N/C</td></tr> <tr><td>2</td><td>XMT</td></tr> <tr><td>3</td><td>N/C</td></tr> <tr><td>4</td><td>RXD</td></tr> <tr><td>5</td><td>GND</td></tr> <tr><td>6</td><td>GND</td></tr> <tr><td>7</td><td>+5V</td></tr> <tr><td>8</td><td>+12V</td></tr> </tbody> </table>	Pin	Description	1	N/C	2	XMT	3	N/C	4	RXD	5	GND	6	GND	7	+5V	8	+12V	<p>4-Pin power input</p>  <p>Outside view (Male)</p> <table border="1" data-bbox="1153 315 1412 504"> <thead> <tr> <th>Pin</th> <th>Description</th> </tr> </thead> <tbody> <tr><td>1</td><td>+12V Input</td></tr> <tr><td>2</td><td>GND</td></tr> <tr><td>3</td><td>N/C</td></tr> <tr><td>4</td><td>N/C</td></tr> </tbody> </table>	Pin	Description	1	+12V Input	2	GND	3	N/C	4	N/C				
Pin	Description																																
1	N/C																																
2	XMT																																
3	N/C																																
4	RXD																																
5	GND																																
6	GND																																
7	+5V																																
8	+12V																																
Pin	Description																																
1	+12V Input																																
2	GND																																
3	N/C																																
4	N/C																																
<p>4-Pin Amp J-Box Interface</p>  <p>Outside view (Female)</p> <table border="1" data-bbox="519 882 779 1071"> <thead> <tr> <th>Pin</th> <th>Description</th> </tr> </thead> <tbody> <tr><td>1</td><td>+ Excitation</td></tr> <tr><td>2</td><td>- Bridge</td></tr> <tr><td>3</td><td>+ Bridge</td></tr> <tr><td>4</td><td>- Excitation</td></tr> </tbody> </table>	Pin	Description	1	+ Excitation	2	- Bridge	3	+ Bridge	4	- Excitation	<p>2-Pin power input</p>  <p>Outside view (Female)</p> <table border="1" data-bbox="1153 882 1412 987"> <thead> <tr> <th>Pin</th> <th>Description</th> </tr> </thead> <tbody> <tr><td>A</td><td>+12V</td></tr> <tr><td>B</td><td>GND</td></tr> </tbody> </table>	Pin	Description	A	+12V	B	GND																
Pin	Description																																
1	+ Excitation																																
2	- Bridge																																
3	+ Bridge																																
4	- Excitation																																
Pin	Description																																
A	+12V																																
B	GND																																
<p>5-Pin Weigh Bar input</p>  <p>Outside view (Female)</p> <table border="1" data-bbox="519 1428 779 1659"> <thead> <tr> <th>Pin</th> <th>Description</th> </tr> </thead> <tbody> <tr><td>A</td><td>- Bridge</td></tr> <tr><td>B</td><td>+ Excitation</td></tr> <tr><td>C</td><td>+ Bridge</td></tr> <tr><td>D</td><td>- Excitation</td></tr> <tr><td>E</td><td>Shield</td></tr> </tbody> </table>	Pin	Description	A	- Bridge	B	+ Excitation	C	+ Bridge	D	- Excitation	E	Shield	<p>RD40/XL input</p>  <p>Outside view (Male)</p> <table border="1" data-bbox="1153 1428 1412 1785"> <thead> <tr> <th>Pin</th> <th>Description</th> </tr> </thead> <tbody> <tr><td>1</td><td>+12V</td></tr> <tr><td>2</td><td>+5V</td></tr> <tr><td>3</td><td>GND</td></tr> <tr><td>4</td><td>Remote-2</td></tr> <tr><td>5</td><td>N/C</td></tr> <tr><td>6</td><td>Data In</td></tr> <tr><td>7</td><td>Clock</td></tr> <tr><td>8</td><td>N/C</td></tr> <tr><td>9</td><td>Remote-1</td></tr> </tbody> </table>	Pin	Description	1	+12V	2	+5V	3	GND	4	Remote-2	5	N/C	6	Data In	7	Clock	8	N/C	9	Remote-1
Pin	Description																																
A	- Bridge																																
B	+ Excitation																																
C	+ Bridge																																
D	- Excitation																																
E	Shield																																
Pin	Description																																
1	+12V																																
2	+5V																																
3	GND																																
4	Remote-2																																
5	N/C																																
6	Data In																																
7	Clock																																
8	N/C																																
9	Remote-1																																

3 User Menu

This section takes you through the User menu. You will use this menu to set many of the scale functions.

Access this menu from the G/N mode by pressing the **HOLD/MENU** key for two beeps. See Figure 3.1.

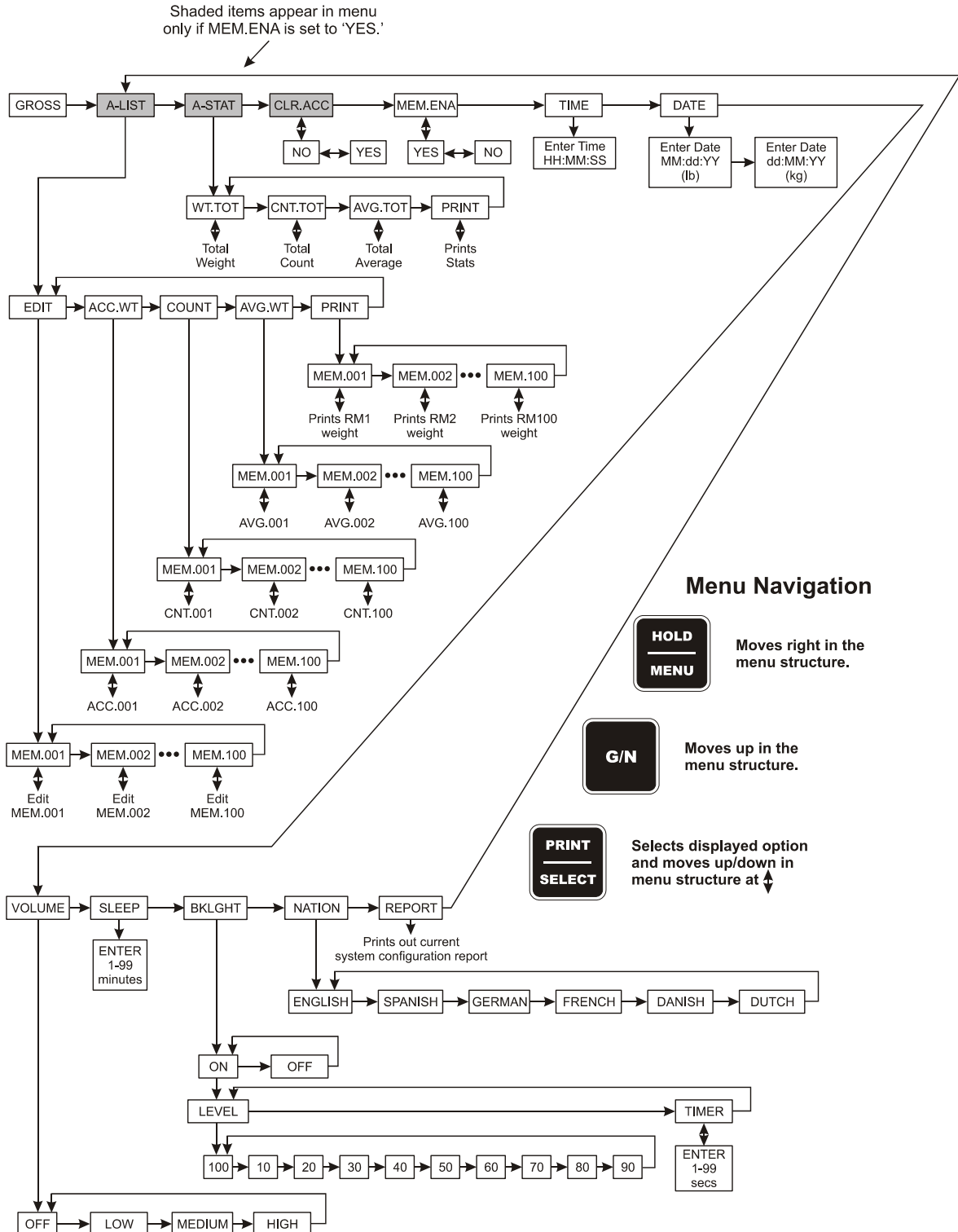
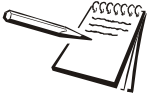

Figure 3.1 User Menu

Below is a summary of the items in this menu, followed by a comprehensive explanation of each item:

- A-LIST** Used to edit the memory accumulator descriptions
- A-STAT** Used to access statistics of the memory accumulator channels
- CLR.ACC** Use this to clear accumulator channels
- MEM.ENA** Use this to disable or enable memory channel functions. If enabled, **A-LIST**, **A-STAT** and **CLR.ACC** do not appear in the user menu.
- TIME** Use to set the time
- DATE** Use to set the date
- VOLUME** Use to set the volume of the audible key buzzer.
- SLEEP** Use to set the amount of inactive time before the indicator turns itself off.
- BKLGHT** Use to set the backlight brightness.
- NATION** Use to set the spelling of messages in the following: English, Spanish, French, German, Dutch and Danish
- REPORT** Use to print out indicator 'system configuration settings'.

3.1 Editing The A-LIST



The A-LIST item is only active if the MEM.ENA menu item is set to YES.



Menu Navigation



Moves right in the menu structure.



Moves up in the menu structure.



Selects displayed option and moves up/down in menu structure at 

If the application requires alphanumeric channel names, go through the memory channel list and edit their descriptions accordingly. For example, if you want to record grain cart loads from five different fields, then create a list of FIELD1, FIELD2, ...FIELD3. Now the custom names of the memory channels can be used, otherwise all memory channels will be the default descriptions of MEM.001, MEM.002, etc.

1. From the G/N mode, press **HOLD/MENU** for 2 beeps...
A-LIST is shown on the display. (Only appears if **MEM.ENA** is enabled)
2. Press the **PRINT/SELECT** key...
EdiT is displayed
3. Press **PRINT/SELECT** again and ...
MEM.001 is displayed, or the last memory channel accessed.
- 4a. Use the **MENU** key to scroll to the channel you want to edit
OR
- 4b. Use the **RM^** and **MENU** keys to enter in the position on the list of the memory channel name to edit.

EXAMPLE: To edit MEM.025, press **RM^** three times to enter the '2'. Press **MENU** to move the cursor. Enter the '5' by pressing **RM^** six times and press **ENTER**. This procedure takes you directly to the 25th channel in the list.
5. When the desired channel name is found, press **SELECT** and you are now in Edit mode. The annunciators should be flashing when in this mode.
6. Using the **RM^** key, start entering the new channel name. Press **MENU** to move the cursor. To move the cursor back one character, press the **TARE** key.

7. Press **SELECT** when the desired name has been entered. The display will now show the channel name list. Repeat steps 3 - 7 to edit more channel names.
8. Press **G/N** three times to return to G/N weighing mode.

3.2 Accessing the Accumulator Statistics



This item is only active if the MEM.ENA menu item is set to YES.

This section allows you to access the accumulator statistics.

1. From the G/N mode, press and hold the **HOLD/MENU** key for two beeps (2 sec), then release...
A-LIST is displayed.
2. Press the **HOLD/MENU** key once...
A-STAT is displayed. This stands for accumulator statistics.
3. Press the **PRINT/SELECT** key...
WT.TOT is displayed.
4. Press the **PRINT/SELECT** key...
Total weight accumulated in all the accumulators is displayed.
5. Press the **PRINT/SELECT** key...
WT.TOT is displayed.
6. Press the **HOLD/MENU** key once...
CNT.TOT is displayed.
7. Press the **PRINT/SELECT** key...
The total number or count of accumulations performed is shown.
8. Press the **PRINT/SELECT** key...
CNT.TOT is displayed.
9. Press the **HOLD/MENU** key ...
AVG.TOT is displayed.
10. Press the **PRINT/SELECT** key...
The average weight of all accumulations is displayed.
11. Press the **PRINT/SELECT** key...
AVG.TOT is displayed.
12. Press the **HOLD/MENU** key ...
PRINT is displayed.

13. Press the **PRINT/SELECT** key ...

The statistics printout is transferred to the TDM or printer device. A sample is shown below:

```
04-25-2006
14:20:26
TOTAL WEIGHT: 1938370 lb
AVG. WEIGHT: 44050 lb
TOTAL COUNT: 44
```

14. Press the **G/N** key to return to **A-STAT**. Press **G/N** key again to return to G/N weighing mode.

3.3 Clearing Accumulators



This item is only active if the **MEM.ENA** menu item is set to **YES**.



Menu Navigation



Moves right in the menu structure.



Moves up in the menu structure.



Selects displayed option and moves up/down in menu structure at 

This section allows you to clear the accumulators.

- From the G/N mode, press and hold the **HOLD/MENU** key for two beeps (2 sec), then release...
A-LIST is displayed.
- Press the **HOLD/MENU** key repeatedly until...
CLR.ACC is displayed.
- Press the **PRINT/SELECT** key...
NO is displayed.
- Press the **HOLD/MENU** key...
YES is displayed.

5. Press the **PRINT/SELECT** key...

WAIT is displayed while clearing, then **MEM.CLR** is briefly displayed, then unit returns to the G/N weighing mode.

3.4 Viewing or Changing the Time

The Model 640 has standard battery backed time and date features. The time can be configured for 24 hour or 12 hour clock for printouts in the 640 menu, but must always be entered first as 24 hr entry:

1. From the G/N mode, press and hold the **HOLD/MENU** key for two beeps (2 sec), then release...

A-LIST is displayed.

2. Press the **HOLD/MENU** key repeatedly until...

TIME is displayed.

3. Press **PRINT/SELECT** and ...

Current time is shown ticking.

- 4a. Press **PRINT/SELECT** to accept displayed time...

TIME is displayed.

OR

- 4b. To change time, use the numeric entry procedure to enter HHMMSS and press **PRINT/SELECT** to accept...

TIME is displayed.

5. Press the **G/N** key...

Returns to the G/N mode.



Numeric Entry Procedure



Press this key to enter a value on the screen and increment the value being entered.



Press this key to decrement the numeric value being entered.



Press this key to move the numeric entry cursor one position to the right.

3.5 Viewing or Changing the Date

The indicator has battery backed time and date standard. The date can be entered as follows:

1. From the G/N mode, press and hold the **HOLD/MENU** key for two beeps (2 sec), then release...
A-LIST is displayed.
2. Press the **HOLD/MENU** key repeatedly until...
dATE is shown.
3. Press the **PRINT/SELECT** key
MMddYY (lb)
or
ddMMYY(kg) is displayed momentarily, then current date setting is shown.
4. Use the numeric entry procedure to enter the date.
(lb) enter MMddYY
(kg) enter ddMMYY
5. Press the **PRINT/SELECT** key to accept the displayed date...
dATE is shown.
6. Press the **G/N** key...
Indicator returns to the G/N mode.

3.6 Entering / Viewing the Audible Keypad Setting

The Model 640 keys have audible feedback that can be configured for off, low, medium, or high. (Default is high)

1. From the G/N mode, press and hold the **HOLD/MENU** key for two beeps (2 sec), then release...
A-LIST is displayed.
2. Press the **HOLD/MENU** key repeatedly until...
VOLUME is displayed
3. Press the **PRINT/SELECT** key...
Current setting is shown.
4. Press **HOLD/MENU** repeatedly until appropriate setting is shown, then press **PRINT/SELECT**...
VOLUME is displayed.
5. Press the **G/N** key...
Returns to the G/N weighing mode.

3.7 Entering / Viewing the Sleep Parameter

The Model 640 has a sleep mode that can shut the unit off if the following conditions occur:

- The indicator doesn't see any keys being pressed, or
- The weight hasn't changed by more than 1% over the number of minutes that was entered for the sleep setting.

Setting the Sleep setting (DEFAULT = 0, for off)

1. From the G/N mode, press and hold the **HOLD/MENU** key for two beeps (2 sec), then release...

A-LIST is displayed.

2. Press the **HOLD/MENU** repeatedly until...

SLEEP is displayed.

3. Press the **PRINT/SELECT** key...

Current setting is displayed.

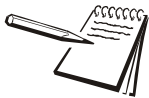

*When the unit goes to sleep, the unit will first activate the audible alarm, and user has 10 seconds to press a key to reset the SLEEP timer. If a key hasn't been pressed within these 10 seconds the display shows **SHTDWN**, and the unit shuts off.*

4. Use the numeric entry procedure and enter in the sleep shutoff setting from 0-99 minutes...

Entered value is displayed.

5. Press the **PRINT/SELECT** key...

SLEEP is displayed.

6. Press the **G/N** key...

Returns to the G/N mode.

3.8 Setting the Backlight Operation

The Model 640 has a backlight you can configure. Follow these steps to configure backlight operation.

1. From the G/N mode, press and hold the **HOLD/MENU** key for two beeps (2 sec), then release...

A-LIST is displayed.

2. Press the **HOLD/MENU** key repeatedly until....

BKLGHT is displayed.

3. Press the **PRINT/SELECT** key...

Current setting is displayed. (**ON** or **OFF**)

4. Press the **HOLD/MENU** key to toggle between the two settings. Press **PRINT/SELECT** when your choice is displayed. If you choose **ON...**
LEVEL is displayed. Use this to set the illumination level of the backlight (10% to 100%).
5. Press the **PRINT/SELECT** key to access the level...
Current setting is displayed. (100% is default value)
6. Scroll through the choices by repeatedly pressing the **HOLD/MENU** key. Press **PRINT/SELECT** when your choice is displayed.
LEVEL is displayed.
7. Press the **HOLD/MENU...**
TIMER is displayed. Use this to set the amount of time which must pass with no scale or indicator activity before the unit shuts down the backlight for power saving.
8. Press the **PRINT/SELECT** key to access the timer function...
Current setting is displayed.
9. Use the numeric entry procedure to enter a choice in seconds (0-99). Press **PRINT/SELECT** to accept your choice.
TIMER is displayed.
10. Press **G/N** key twice...
BKLGHT is displayed.
11. Press the **G/N** key...
Indicator returns to the G/N mode.

3.9 Entering / Viewing the Language Selection (Not currently functioning)

The Model 640 has a selectable language for the displayed messages and reports.

1. From the G/N mode, press and hold the **HOLD/MENU** key for two beeps (2 sec), then release...

A-LIST is displayed.

2. Press the **HOLD/MENU** key repeatedly until....

NATION is displayed.

3. Press the **PRINT/SELECT** key...

Current setting is displayed.

4. Use the **HOLD/MENU** keys and scroll to the proper language selection...

Proper selection is shown.

5. Press the **PRINT/SELECT** key to accept displayed choice...

NATION is displayed.

6. Press the **G/N** key...

Returns to the G/N mode.

3.10 Printing a Configuration Report

1. From the G/N mode, press and hold the **HOLD/MENU** key for two beeps (2 sec), then release...

A-LIST is displayed.

2. Press the **HOLD/MENU** key repeatedly until....

REPORT is displayed.

3. Press the **PRINT/SELECT** key...

A configuration report on the current status of your indicator is output through the RS-232 port to your connected device.

4. Press the **G/N** key...

Returns to the G/N mode.

A sample report is shown below:

```
-----
System Configuration Settings
04-25-2006    11:29:00
-----
```

```
PART   :      60259-0026
REV    :      1.9.0
```

User's Menu

```
-----
VOLUME:      HIGH
SLEEP TIMER : OFF
BKLIGHT:     ON
  LEVEL  :   100%
NATION:      ENGLSH
MEM.ENA:     ON
```

640 Setup Menu

```
-----
MODE   :      640
CONFIG:      S130
1.0 mV/V:   37470 1b
O-CAP  :     200000 1b
DIV    :           10 1b
PRINT FORMAT: G-T-N w/ Date-Time
CLOCK  :      24 HR
DATE   :      MM-DD-YY
AUT.LOC:      OFF
```

```
AUT.ACC:     OFF
```

```
INPUT1:      STD
INPUT2:      STD
UPDATE:      5 Hz
AVERGE:      30
FILTER:      ON
  CONST  :    2
  WINDOW:    0 1b
AZT   :      OFF
STABLE:      1 DIV
STABLE:      1.0 SEC
```

```
RS232 :
  BAUD  :    9600
  DATA :     8
  PARITY:  NONE
  HAND  :  NONE
  LAYOUT:  STD
  ENQR  :     5
  AUTO  :  OFF
  ACC.PRN: OFF
  CH.NAME: OFF
```

Factory Menu

```
-----
FAC.SPN:     99779
FAC.ZERO:    76370
```

4 Weighing Procedures

This section covers the procedures for different weighing processes.

4.1 Simple Weighing

1. Press **ON**...
Display shows **HELLO** then the current weight value is displayed.
2. Press **G/N** and access gross mode...
Live scale weight is displayed in the G/N weighing mode.
3. Remove all material from the scale and press **ZERO/CLEAR**
0 is displayed, and the system is zeroed.



Establishing zero here is the same as doing the calibration zero.

If unit is in AUTO-LOC mode and L is displayed, to zero the scale, press and hold the ZERO/CLEAR key for two seconds.

4.2 Gross/Tare/Net (GTN) Weighing (single tare example)

For GTN weighing (weighing net amounts), follow these steps:

1. Press **ON**...
Display shows **HELLO** then the current weight value is displayed.
2. Press **G/N** to access the gross mode...
Live scale weight is displayed in the G/N weighing mode.
3. Remove all material from the scale and press **ZERO/CLEAR**
0 is displayed, and the system is zeroed.



The zero point established at this point is the same as calibration zero. If a system is set at 20000 lb, and a user tares at 18000, then the system can only allow another 2000 lb before displaying (-----) upper dash lines for overcapacity.

*If no tare weight has been established, push **G/N** key to show **NO TARE**.*

4. Place material to be tared on the scale...
Weight of material is displayed.
5. Press the **TARE** key to tare the weight from the display...
0 weight is displayed and the *Net* annunciator lights to indicate there is an active tare weight.

6. Place the material to be weighed on the scale...
Net weight is displayed.
7. Remove the weighed material from the scale (leaving the tared item).
8. Repeat steps 6 through 7 for each weighment using the same tare weight.
9. To remove the tare weight, press the **G/N** key to return to gross weigh mode, then press the **ZERO/CLEAR** key...

The tare weight is removed and you can repeat this process to weigh more material with a different tare.

4.3 Loading or Unloading Consecutive Net Amounts

This procedure allows the user to load/unload a series of net amounts. This procedure is ideal for TMR mixers, weigh carts, grain carts, etc. for viewing and recording net amounts of material loaded and unloaded.

1. In gross mode, press the **ZERO/CLEAR** key to zero the indicator when the mixer or scale system is empty.
2. After initial amount is placed on the scale, press the **TARE** key...
Weight is tared off and goes into net mode, showing 0 weight.
3. Load or Unload material as needed...
Shows + when loading and a – value when unloading.
4. When the display reaches the proper amount, stop loading or unloading material.
5. Repeat steps 2 through 4 until complete.

4.4 Loading/Unloading Net Amounts (XM64 Transmitter)

This procedure allows the user to load/unload a series of ingredient/unload amounts by using the XM64 transmitter/receiver. This procedure implies that the end user knows the net amounts that must be loaded or unloaded. The XM64 gives the user the ability to tare or zero each ingredient and view the net amount as loading or unloading. It also can be used to indicate the G/N amount between ingredients and can return the indicator to the G/N mode when done loading by holding down on the XM64 for three or more seconds.

1. In gross mode, press the **ZERO/CLEAR** key to zero the indicator when the mixer or scale system is empty.
2. After material is placed on the scale, press the XM64 key...
Weight is tared off and goes into net mode, showing 0 weight.
3. Load or Unload material as needed...
Shows + when loading and a – value when unloading.
4. When the display reaches the proper amount, stop loading or unloading material.

- Repeat steps 2 through 4 until complete.

You may now view the G/N weight by pressing and holding the XM64 button, once. Releasing the button if within three seconds unit returns to the net mode showing zero.

If you are done loading and now want to return to the G/N mode for unloading, press and hold the XM64 for more than three seconds.

4.5 Using Memory Channels to Accumulate

The Model 640 has 100 memory channels available for accumulating weights. This can be helpful in accumulating loads of feed on a mixer, grain cart or weigh cart yields, or setting up groups of livestock. Each channel will also have the total number of accumulations obtained, total weight and the average weight of all weights accumulated, both total and for each individual channels.

4.5.1 Editing Memory Channel List

If the application requires alphanumeric channel names, go through the memory channel list and edit their descriptions accordingly. For example, if you want to record grain cart loads from five different fields, then create a list of FIELD1, FIELD2, ...FIELD3. Now the custom names of the memory channels can be used, otherwise all memory channels will be the default descriptions of MEM.001, MEM.002, etc.

- From the G/N mode, press **HOLD/MENU** for 2 beeps...
 - A-LIST** is shown on the display. (Only appears if **MEM.ENA** is enabled)
- Press the **PRINT/SELECT** key...
 - EdiT** is displayed
- Press **PRINT/SELECT** again and ...
 - MEM.001** is displayed, or the last memory channel accessed.
- 4a. Use the **MENU** key to scroll to the channel you want to edit
- OR**
- 4b. Use the **RM^** and **MENU** keys to enter in the position on the list of the memory channel name to edit.
 - EXAMPLE: To edit MEM.025, press **RM^** three times to enter the '2'. Press **MENU** to move the cursor. Enter the '5' by pressing **RM^** six times and press **ENTER**. This procedure takes you directly to the 25th channel in the list.
5. When the desired channel name is found, press **SELECT** and you are now in Edit mode. The annunciators should be flashing when in this mode.
6. Using the **RM^** key, start entering the new channel name. Press **MENU** to move the cursor. To move the cursor back one character, press the **TARE** key.
7. Press **SELECT** when the desired name has been entered. The display will now show the channel name list. Repeat steps 3 - 7 to edit more channel names.
8. Press **G/N** three times to return to G/N weighing mode.

4.5.2 Accessing Memory Channels

1. From the G/N mode, press the **RM[^]** key...
MEM.001 is shown or the last accessed channel.

This will now access the MEM.001 channel. If you want any other channel either use the **HOLD/MENU** key to scroll to the proper channel, or use the **RM[^]** and the **HOLD/MENU** key to access directly to channel **XX**, then press **PRINT/SELECT**.
2. Press **HOLD/MENU** twice, and...
MEM.003 is shown
3. Either press the **G/N** key to return to gross weighing, or wait 3 seconds and it will automatically return to the gross weighing mode.

4.5.3 Using Memory Channels to Accumulate

1. Press **M+** and the following is displayed:
Active memory channel is shown
M+
TOTAL
Actual Accumulated total is shown
2. If accumulated in error, press and hold **M+** until the second beep and the following is displayed...
Active memory channel is shown
DELETE
TOTAL
New Actual Accumulated total is shown

4.5.4 Clearing the Accumulators

1. From the G/N mode, press and hold on the **HOLD/MENU** key for two beeps (2 sec) and release...
A-LIST is shown.
2. Press **HOLD/MENU** twice...
CLR.ACC is shown
3. Press **PRINT/SELECT**...
NO is displayed.
4. Press **HOLD/MENU**...
YES is displayed.

5. Press **PRINT/SELECT...**
WAIT is displayed, then **MEM.CLR**. Once the unit is done clearing accumulators **CLR.ACC** is displayed again.
6. After the accumulators are cleared press **G/N** to return to the G/N weighing mode.

4.5.5 To Clear a Specific Memory Channel

1. Access the proper memory channel.
2. From the G/N mode, press and hold **ZERO/CLEAR** key until the second beep...

MEM.XXX is displayed then **MEM.CLR** is displayed. MEM.XXX is now cleared.

4.5.6 To Print an Individual Memory Channel

1. From the G/N mode, press the **RM** key...

MEM.001 is displayed or the last accessed memory channels.

This will now access the MEM.001 channel. If you want any other channel either use the **HOLD/MENU** key to scroll to the proper channel, or use the **RM** and the **HOLD/MENU** key to access directly to channel **XX**, then press **PRINT/SELECT**.



Accumulators can go as far as 99,000,000.

2. Once the proper channel is displayed, press **PRINT/SELECT** and the following report will be printed to the printer or TDM module.

Before printing **PR-RM** is shown on the display...

```

09-11-2007
11:12:17
CHANNEL:          1
NAME:             MEM.001

ACCUM. WEIGHT:   1000000 lb
ACCUM. COUNT:    20
ACCUM. AVERAGE: 50000 lb
    
```

3. The indicator automatically returns to the gross weighing mode.

4.5.7 To Print All Memory Channels

1. Press **RM^**...

Latest memory channel is displayed.

2. Press **PRINT/SELECT** for 2 secs...

PR-ALL is momentarily displayed and information is transmitted.



The indicator will only print out memory channels that have accumulated weight amounts.

3. Indicator returns to gross weighing mode.

Mem channel printout

04-25-2006

14:17:19

MEM CH	COUNT	AVG WT	TOTAL
FIELD1	18	29980 lb	539550 lb
FIELD2	14	51390 lb	719390 lb
CUSTOM	12	56620 lb	679430 lb
TOTAL	44	44050 lb	1938370 lb

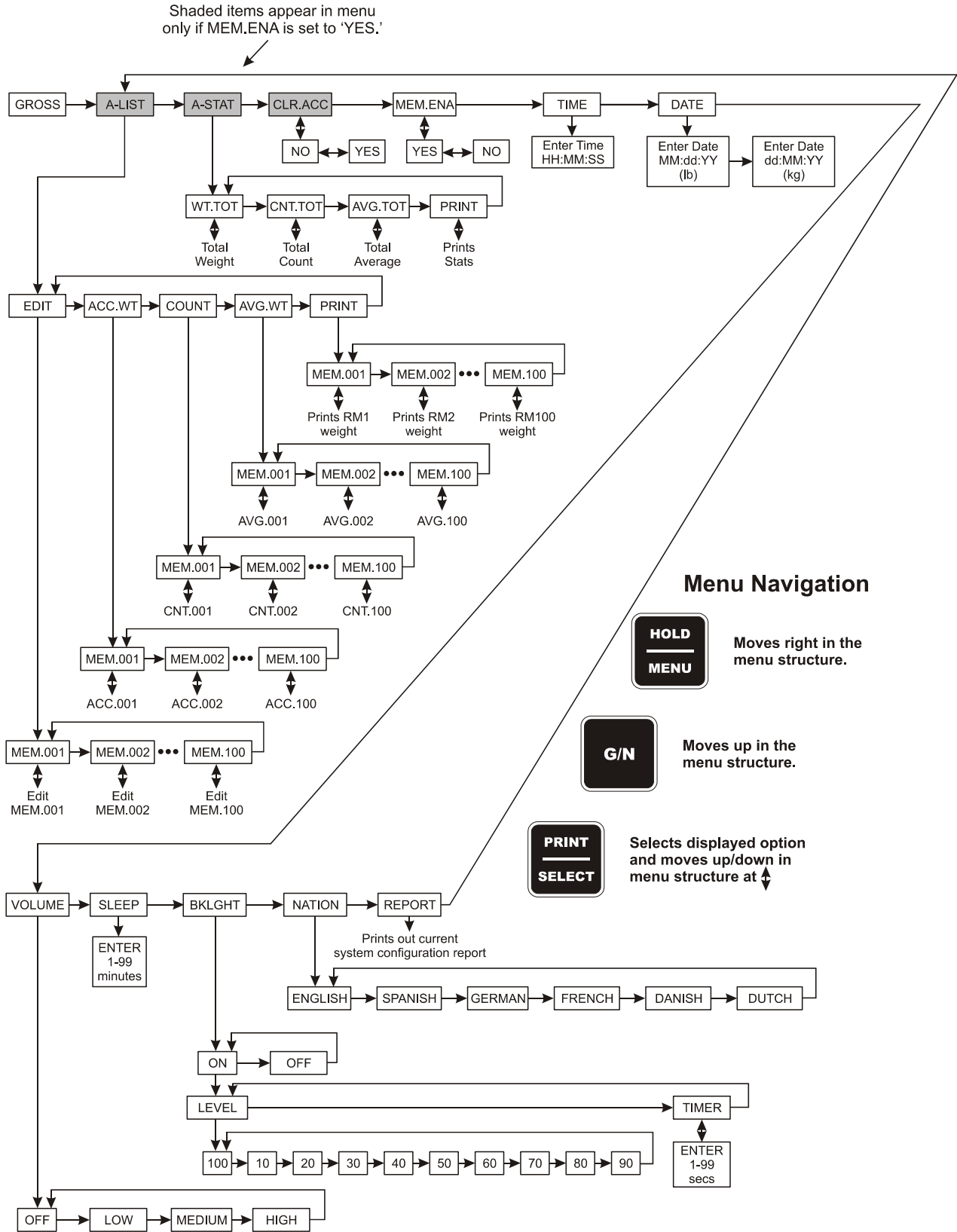

Figure 4.1 Menu

4.6 Manual Hold for Mobile Systems

The Model 640 has a manual hold using the **HOLD/MENU** key to prevent a zero shift from occurring on any portable scale system (i.e. mixer, weigh cart, grain cart, etc.). To use the **HOLD/MENU** key to prevent any small zero shifts from occurring while moving a system over rough farm terrain, follow these steps.



When using the hold mode, user must be sure hold mode has been deactivated when loading or unloading to the mixer.

1. In the G/N Mode, before moving the mixer system press **HOLD/MENU**...
HOLD will be displayed.
2. Now move the system and when reaching the new loading or unloading point, press either the **HOLD/MENU** or **G/N** key...
G/N weight will be displayed.

4.7 Using Hold Mode for Maintaining Weight Overnight

The Model 640 has a **HOLD/MENU** key to prevent minimal scale weight shifts due to temperature changes.

1. In the gross weighing mode, when you are finished with the scale for the day, but material is left on the scale, press the **HOLD/MENU** key...
HOLD is displayed.
2. Turn the system off for the night.
3. The following day turn the unit on by pressing the **ON/OFF** key...
HOLD is displayed.
4. Press **G/N** key and...
Exact weight from the previous day is displayed.

4.8 Animal Weighing Using AUTO-LOC Feature

The Model 640 has a feature called AUTO-LOC. It is specifically designed for use in weighing livestock. Once the indicator has determined the animal's weight, the indicator display automatically locks on that weight. The weight reading will not change as long as the animal is on the scale. This makes the weight easy to record since the numbers are not rapidly changing as the animal moves on the scale.



AUTO accumulate feature can be turned on or off to work with AUTO-LOC. Refer to Figure 8.3 Table for 5th CCN Digit on page 55 to choose a 5th digit of the CCN which will turn on the accumulator.

There are two modes in the Auto-LOC feature:

Standard LOC Mode

In standard mode, an animal's weight is locked on the display until the animal leaves the scale.

Advanced LOC Mode

In advanced mode, an animal's weight is locked on the display until the next animal comes onto the scale.

4.8.1 How to Set Up AUTO-LOC

Follow these steps to set up the AUTO-LOC feature:

1. Access the Setup menu from the G/N mode. Press and hold the **HOLD/MENU** key for three beeps (3 seconds), then release...

SET.PAS is displayed.

2. Use the numeric entry procedure, described below, to enter the password **640**. Press **PRINT/SELECT** to accept it...

640 is shown.



Numeric Entry Procedure



Press this key to enter a value on the screen and increment the value being entered.



Press this key to decrement the numeric value being entered.



Press this key to move the numeric entry cursor one position to the right.

-
3. Press **PRINT/SELECT** once more...

CONFIG is displayed. Change your current configuration code number to one that turns AUTO-LOC on. Refer to Figure 8.3 Table for 5th CCN Digit on page 57. Once you have your five digit number, enter it as follows:

4. From **CONFIG**, press **PRINT/SELECT**...

Current code number is shown.

5. If attempting to enter an invalid number display will show CAN't and return to CONFIG.

6. Use the numeric entry procedure to enter the new number and press the **PRINT/SELECT** key when finished.

CONFIG is shown.

7. Press the **HOLD/MENU** key several times until...

AUT.LOC appears. The **AUTO-LOC** menu selection only shows up when a configuration code number turns on this feature.

This menu item is where you choose standard or advanced LOCK, minimum weight (**MIN.WT**), and release tolerance (**REL.TOL**) appropriate for the livestock application.
8. Press the **PRINT/SELECT** key...

MODE is displayed.
9. Press the **PRINT/SELECT** key...

STD.LOC is displayed. This is the standard LOCK. Toggle between this and the **ADV.LOC** by pressing the **HOLD/MENU** key.
10. When your choice is displayed, press the **PRINT/SELECT** key...

Your choice is selected and **MODE** is displayed.
11. Press the **HOLD/MENU** key...

MIN.WT is displayed. This is where you set the minimum weight that must be on the scale to activate the AUTO-LOC feature. This prevents smaller weights from locking on the display. See the example below.



EXAMPLE: *If you are weighing 1200 pound cattle, you may set the minimum weight at 800 pounds and a release tolerance of 25%. Anything thing that goes on the scale that weighs less than 800 pounds (like a person or the neighborhood dog) will not cause the weight to lock. When an animal steps off the scale and the weight drops by at least 300 pounds (25% of 1,200 pounds), the system will reset to lock on the next weight above 800 pounds.*

12. To set the minimum weight, press the **PRINT/SELECT** key...

Use the numeric entry procedure to enter the minimum weight value.
13. When the value is entered, press the **PRINT/SELECT** key to accept it and...

MIN.WT is displayed.
14. Press the **HOLD/MENU** key...

REL.TOL is displayed. This is the release tolerance. This is set in steps [12](#) and [13](#) which must be removed from the scale before the AUTO-LOC resets. See example in the left margin of page [39](#).
15. Press the **PRINT/SELECT** key...

Use the numeric entry procedure to enter the release tolerance in percentage of the minimum weight.
16. When the value is entered, press the **PRINT/SELECT** key to accept it and...

Your choice is selected and **REL.TOL** is displayed.

You can exit the menu and return to normal weighing mode by repeatedly pressing the **G/N** key. If, during operation the AUTO-LOC feature seems very slow, this can be due to excessive weight fluctuations. In this case you can access the Setup menu and increase the FILTER-CONSTANT parameter until it works properly. Reference *How to Configure Filtering* on page 60 for instructions on adjusting the filtering.

4.8.2 Weighing Individual Animals with Standard Mode AUTO-LOC

The following describes how a Model 640 can be used for weighing and recording an animal's weight automatically on a single animal livestock scale with standard mode AUTO-LOC. Unit must be setup for AUTO-LOC and set for standard (STD.LOC) mode.

1. Turn indicator on, press the **G/N** key to access the gross mode and press the **ZERO** key...

0 is displayed.

2. Move animal onto the scale...

L WWWWW is shown

WWWWW = animals auto-locked weight

If a false locked weight occurred, press **ZERO/CLEAR** to recheck the animals weight. This will also delete from the accumulators the last locked-on weight and replace it with the new locked-on weight.

If auto-accumulate is on, once the weight is locked-on, the Model 640 will automatically accumulate to the last selected memory channel.

Weight stays locked until the weight on the scale drops by the programmed release tolerance. (Example: weighing a 2000 lb animal with a 25% release tolerance, means the lock will release when weight drops below 1500 lb).

If the animal is released and the weight falls below the tolerance it may be possible to lock on another weighment. We recommend putting in a high release tolerance like 75% to insure reliable operation.

Also to prevent an inadvertent AUTO-LOC if someone leans/steps on the scale, we recommend putting in a large amount for the MIN.WT parameter to prevent this from occurring. (EX: 300 lb)

3. Remove the animal from the scale...

Scale returns to live weighing mode

4. Repeat steps 2 and 3.

4.8.3 Weighing Individual Animals with Advanced Mode AUTO-LOC

The following describes how a Model 640 can be used for weighing and recording animal's weight automatically on a single animal livestock scale using the advanced AUTO-LOC mode. The indicator must be setup for AUTO-LOC and set for advanced (ADV.LOC) mode. In addition, the auto-accumulate feature can be turned on or off.

The M640 will lock on an animals weight and stay locked even after the animal is off the scale. A new AUTO-LOC weight will only be retriggered upon placing the next animal on the scale.

1. Turn indicator on use the G/N key to access the gross mode, and press the **ZERO CLEAR** key...

Display shows 0

2. Move animal onto the scale...

L WWWWW is shown. **WWWWW** = animals auto-locked weight

If a false locked weight occurred, press **ZERO/CLEAR** to recheck the animals weight. This will also delete from the accumulators the last locked-on weight and replace it with the new locked-on weight.

If autoaccumulate is on, once the weight is locked-on, the Model 640 will automatically accumulate to the last selected memory channel.

Weight stays locked until the next animal is on the scale.

Also to prevent an inadvertent AUTO-LOC if someone leans/steps on the scale, we recommend putting in a large amount for the MIN.WT parameter to prevent this from occurring. (EX: 300 lb)

3. Remove the animal...

L WWWWW is shown

4. Repeat steps 2 and 3...

After weight starts rising and goes beyond the MIN.WT the scale will briefly show actual weight before triggering a new auto-locked weight.

4.9 Printing

Press the **PRINT** key from G/N mode to print the currently configured print format 0-9 formats.

The default print format is #3. To use any of the other nine formats, see the *Service Manual* on how to select formats, by changing the configuration code number (CCN).



If the *CHNAME* parameter is set to *ON*, the current memory channel name will be added to the start of each print format. To enable this, reference the *Service Manual* or call your dealer for support.

EXAMPLES:

```

MEM.001
G: 32010 1b
  
```

OR

```

MEM.001
04-26-2006
03:02:47
G: 32010 1b
  
```

Format 0

```

G: 32010 1b
  
```

Format 1

```

G: 32010 1b
T: 16010 1b
N: 16000 1b
  
```

Format 2

```

04-26-2006
03:02:47
G: 32010 1b
  
```

Format 3 (default)

```

04-26-2006
03:02:47
G: 32010 1b
T: 16010 1b
N: 16000 1b

```

Format 4

```

32010 1b

```

Format 5

```

32010 1b, 16010 1b, 16000 1b

```

Format 6

```

04-26-2006,03:02:47, 32010 1b

```

Format 7

```

04-26-2006,03:02:47, 32010 1b,
16010 1b, 1600 1b

```

Format 8

```

N: 16000 1b

```

Format 9

```
04-26-2006  
03:02:47  
N: 16000 1b
```

5 Test Menu

5.1 Test Menu Summary

The test menu, shown in Figure 5.1, allows you to test the functions of the indicator shown below.

- VOLTS** Monitor the input voltage of the indicator
- LCD** Do a LCD display test.
- KEYPAD** Do a keypad test
- A / D** Do an Analog to Digital Test (A/D)
- SERIAL** Check the serial ports (Port 1).
- INPUTS** Check the inputs.
- SOFT** Verify the software version of the indicator.

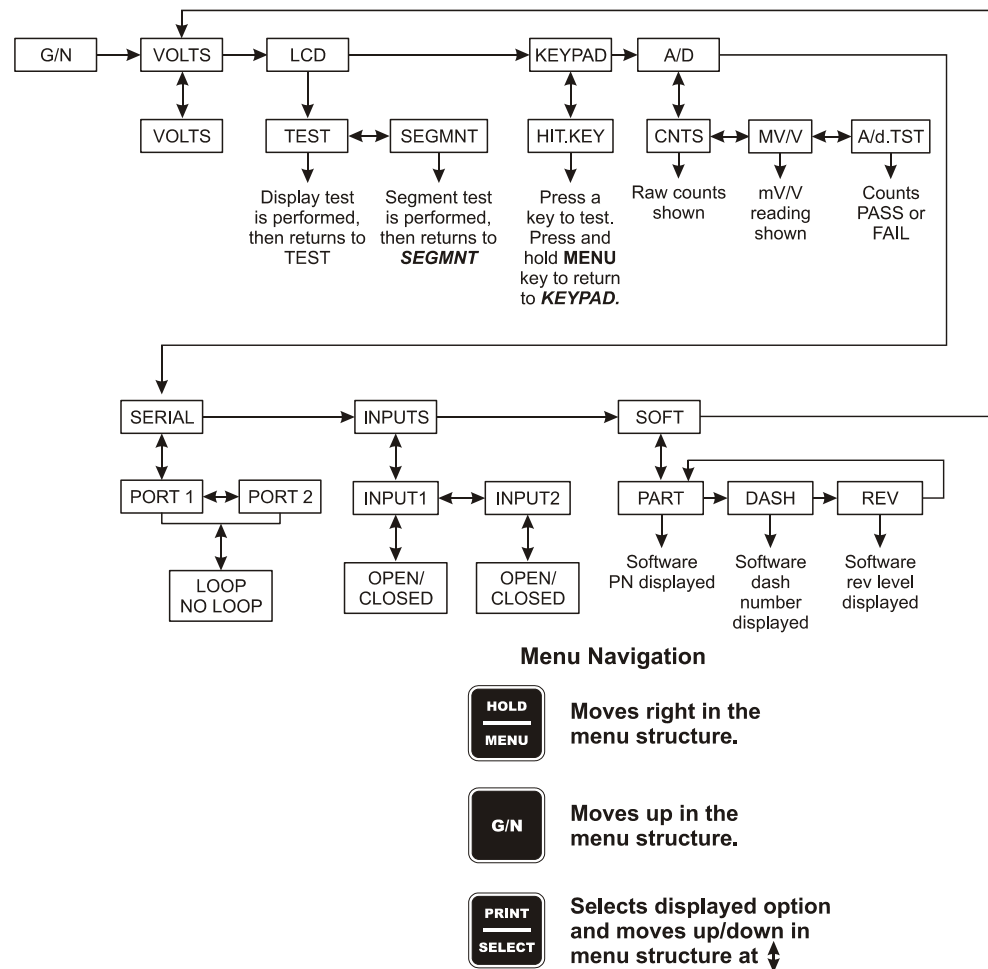

Figure 5.1 Test menu

5.2 Access the Test Menu

To access the Test menu, follow these steps:

- From the G/N mode, press and hold the **HOLD/MENU** key for three beeps (3 seconds), then release...
SET.PAS is displayed.
- Use the numeric entry procedure, shown below, and enter the password 111...
111 is displayed.



Numeric Entry Procedure



Press this key to enter a value on the screen and increment the value being entered.



Press this key to decrement the numeric value being entered.



Press this key to move the numeric entry cursor one position to the right.

- Press the **PRINT/SELECT** key...
VOLTS, the first menu item, is displayed.

5.3 Test Menu Items

5.3.1 VOLTS (Input voltage)

This allows a user to check the voltage coming into the indicator.

- Access the test menu...
VOLTS is displayed.
- Press the **PRINT/SELECT** key, and...
Current voltage is displayed.
- Press the **G/N** key to return to the G/N weighing mode.

5.3.2 LCD (LCD Display test)

Use this to perform a self test on the LCD, either a complete display test or a segment test.

1. From **VOLTS** press menu...
LCd is displayed.
2. Press the **PRINT/SELECT** key...
TEST is shown.
3. Press the **PRINT/SELECT** key...
Display performs a test (15 sec).
4. When test is completed...
TEST is shown.
5. Press **HOLD/MENU**...
SEGMNT is displayed.
6. Press the **PRINT/SELECT** key...
Display performs a segment test.
7. When test is completed...
SEGMNT is displayed.
8. Press **G/N** key to...
Return to **LCd** display.
9. Press **G/N** key to return to the G/N weighing mode.

5.3.3 KEYPAD (Keypad test)

This test allows testing of all active keys...

1. From **VOLTS**, press **HOLD/MENU**...
LCd is displayed.
2. Press the **HOLD/MENU** key repeatedly until...
KEYPAD is shown.
3. Press the **PRINT/SELECT** key...
HIT.KEY is displayed briefly, then **NO KEY** is shown if a key isn't being pressed. Test the key by pressing it. If it is working the corresponding key name will be displayed. See table below:

Press the G/N key	G/N is displayed.
Press the HOLD/MENU key	HOLD is displayed.
Press the ZERO/CLEAR key	ZERO is displayed.
Press the PRINT/SELECT key	PRINT is displayed.
Press the RM key	RM is displayed.
Press the M+ key	M+ is displayed.
4. Press and hold the **HOLD/MENU** key to return to **KEYPAD**.

5.3.4 A/D (View /Test A to D counts)

1. From **VOLTS**, press menu...
LCd is displayed.
2. Press **HOLD/MENU** repeatedly until...
A/d is shown.
3. Press the **PRINT/SELECT** key...
CNTS is shown.
4. Press the **PRINT/SELECT** key...
A/D raw counts are shown.
5. Press the **PRINT/SELECT** key...
CNTS is shown.
6. Press the **HOLD/MENU** key...
mV/V is shown.
7. Press **PRINT/SELECT** key...
The mV/V value is shown.
8. Press **PRINT/SELECT** key...
mV/V is shown.
9. Press **HOLD/MENU** key...
A/d.TST is shown.
10. Press **PRINT/SELECT** key...
Counts PASS or **FAIL** is shown.
11. Press **PRINT/SELECT** key...
A/d.TST is shown.
12. Press the **G/N** key two times...
Returns to the G/N weighing mode.

5.3.5 SERIAL (Testing Serial Ports)

1. From **VOLTS**, press menu...
LCd is displayed.
2. Press **HOLD/MENU** repeatedly until...
SERIAL is shown.
3. Press the **PRINT/SELECT** key and ...
NOLOOP is displayed.

4. Short the XMT to RCV and...
LOOP will be displayed.
5. Press **PRINT/SELECT** and...
SERIAL is displayed.
6. Press the **G/N** key...
Returns to the G/N weighing mode.

5.3.6 INPUT (Testing the Input)

1. From **VOLTS**, press menu...
LCd is displayed.
 2. Press **HOLD/MENU** repeatedly until...
INPUT is shown.
 3. Press the **PRINT/SELECT** key and ...
INPUT is displayed.
 4. Press the **PRINT/SELECT** key and...
OPEN or **CLOSED** is displayed.
 5. Press the **PRINT/SELECT** key...
INPUT is displayed
- Press **G/N** to return to G/N weighing mode.

5.3.7 SOFT (Software PN, version and revision)

1. From **VOLTS**, press menu...
LCd is displayed.
2. Press **HOLD/MENU** repeatedly until...
SOFT is shown.
3. Press **PRINT/SELECT** and...
PART is displayed. This stands for the part number for the software.
4. Press **PRINT/SELECT** and...
60259 is displayed. This is the software part number.
5. Press the **GN** or **PRINT/SELECT** key...
PART is displayed.
6. Press **HOLD/MENU** and...
DASH is displayed.

7. Press **PRINT/SELECT** and...
-0010 is displayed. This is the software dash number.
8. Press the **GN** or **PRINT/SELECT** key...
DASH is displayed.
9. Press **HOLD/MENU** and...
REV is displayed. This is the software revision number.
10. Press **PRINT/SELECT** and...
Rev A is displayed, for example. This is the software revision level.
11. Press the **GN** or **PRINT/SELECT** key...
REV is displayed.
12. Press **GN** key twice to return to the G/N weighing mode.

6 Remote Displays & XM64 Remote Transmitter

6.1 Remote Displays

The RD40/XL/RF are remote displays that are compatible with the Model 640 indicators. See the photos below. An RD40 output option is required on the Model 640 for interfacing. The interface cable plugs directly into the bottom of the Model 640. Any data displayed on the Model 640 is also displayed on the RD40.



Figure 6.1 RD40XL remote display (XM64 optional)



Figure 6.2 RD40 remote display (mirror mount)

The RD40RF is a wireless remote display which allows full control of the Model 640 from the seven keys on the RD40RF. This is ideal for feed rooms and front end loaders.



Figure 6.3 RD40RF remote display (wireless)

6.2 XM64 Wireless Remote Transmitter

An optional radio remote transmitter (XM64) and receiver can be installed in either the Model 640/XL or the RD40XL.

This option lets the user tare and access net amounts from a remote location, usually a front-end loader. Reference *Loading/Unloading Net Amounts (XM64 Transmitter)* on [page 30](#).

The XM64 can also be configured to simulate any of the seven active keys. See the Service Manual for instructions.

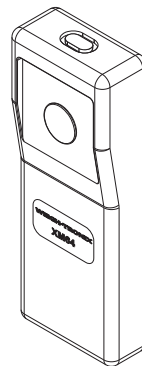

Figure 6.4 XM64

7 Specifications

Power	10 - 17 VDC 55mA @ four weigh bar load, backlight off 270 mA @ four weigh bar load, backlight Optional: 115VAC/12VDC converter
Enclosure	Water and dust resistant, Structural Polycarbonate 8.7" H x 10.5"W x 6.0"D
Display	6 digit, 14 segment, alpha-numeric LED green-yellow backlight, Ten adjustable brightness levels Model 640 - 1.1 inch (28mm) Model 640XL - 2.0 inch (50.8 mm)
Display Rate	Selectable 1, 2, or 5 times/second
Unit of Measure	lb or kg
Excitation	5 volts, drives ten 350 – ohm weigh bars
Analog Range	-0.5 mv/v to 10 mv/v
Annunciators	lb, kg, Auto, Motion, Gross and Net
Operational Keys	ON/OFF, RM, M+, TARE, G/N, HOLD/MENU, PRINT/ SELECT, ZERO/CLEAR (audible key feedback), (Optional: Dealer Service key)
Capacity Range	999,999 lb/kg with decimal down to 2 places
Increment Sizes	Multiples and sub-multiples of 1,2,5 (.01 up to 500)
Internal Resolution	32,212,260 counts per mv/v per second
A/D Conversion Rate	60 times/second
Zero Tracking	Off, 0.5, 1, 2, 3, 5, 10 divisions
Time and Date	Battery backed up real time clock
RS-232 port	Optional bidirectional RS-232 port AMP 8 pin circular connector Response to ASCII character inputs Baud rates (1200 – 115200) Xon/Xoff; Parity selectable, 7/8 data bits Broadcast rate: 1, 2, 5, 10 Hz
RD40/XL Port	Proprietary RD40/XL protocol, required to Interface to RD40 or RD40XL. (9 pin AMP circular connector)
RF Port	802.11G 2.4 GHz WIPORT (required to interface to the wireless RD40RF)
TTL Inputs	XM64 transmitter, programmable inputs Option on 640 or from RD40XL (RM, M+, TARE, G/N, HOLD, PRINT or ZERO/CLEAR)
Environment	-20 to 140 degrees F -29 to 60 degrees C

Weight	5.2 lb / 2.4 kg 7.2 lb / 3.3 kg shipping weight
Agencies	FCC Class A CE marked

8 Appendix: Quick Programming Guide

In most cases your Avery Weigh-Tronix Model 640 arrives from your dealer or distributor preprogrammed with a Configuration Code Number (CCN) that sets the Model 640 to work and weigh properly with the appropriate scale system, whether it is a TMR mixer, grain cart, livestock scale, weigh cart, platform scale, bin scale, or all other applications.

Before beginning to use the new Model 640 scale system, please verify the system has been programmed correctly and is weighing properly and it is configured for the proper unit of measure.

8.1 How to Verify the Scale is Weighing Properly

1. Zero the indicator by pressing the **ZERO/CLEAR** key from the gross mode.
2. Stand on the scale system and note the scale reading.

If the weight reading is correct, your system is working properly and you can continue with operation of the system.

If the weight reading is not correct, read through this Appendix. This will tell you how to access the SETUP menu to change the Configuration Code Number (CCN). This should get your system up and running properly. If you have further problems, call your local dealer or Avery Weigh-Tronix.

8.1.1 To Access the Setup Menu (640)

Follow these steps to access the Setup menu.

1. From the G/N mode, press and hold the **HOLD/MENU** key for three beeps (3 seconds), then release...

SET.PAS is displayed.

2. Use the numeric entry procedure to enter the password **640**. Press **PRINT/SELECT** to accept it...

640 is shown

3. Press **PRINT/SELECT** once more...

CONFIG is displayed. Continue with the next section for instructions on finding and entering the correct Configuration Code Number (CCN) for your indicator.

8.1.2 (CONFIG) Finding and Entering a Configuration Code Number

This section shows you how to find and enter a Configuration Code Number (CCN) that sets up the indicator for the type of weigh-bar, capacity, increment, print format (0-9), units, and AUTO-LOC.

Example:

20,000 x 5 lb, 2 1/8 calibration, print format 3, therefore code= 05233

The Model 640 indicator is precalibrated at Avery Weigh-tronix with appropriate code number specified by the OEM, or leaves with a factory calibration number of 18033.

The following tables show how to establish a configuration code number to configure the Model 640 indicator: Find the specs which match your system to find the appropriate code number. Find the first and second digits of the CCN in Table 8.1.

Table 8.1 .Table for 1st, 2nd and 3rd CCN Digits

1st & 2nd Digits	CALIBRATION SIZE	CAPACITY x INCREMENT SIZE					
00	5/8 *	200 x 0.01	200 x 0.02	200 x 0.05	2K x 0.1	2K x 0.2	2K x 0.5
01	1	2K x 0.1	2K x 0.2	2K x 0.5	20K x 1	20K x 2	20K x 5
02	1-1/4	2K x 0.1	2K x 0.2	2K x 0.5	20K x 1	20K x 2	20K x 5
03	1-7/8	20K x 1	20K x 2	20K x 5	200K x 10	200K x 20	200K x 50
04	2	20K x 1	20K x 2	20K x 5	200K x 10	200K x 20	200K x 50
05	2-1/8	20K x 1	20K x 2	20K x 5	200K x 10	200K x 20	200K x 50
06	2-1/4	20K x 1	20K x 2	20K x 5	200K x 10	200K x 20	200K x 50
07	2-1/4D	20K x 1	20K x 2	20K x 5	200K x 10	200K x 20	200K x 50
08	2-1/4D-P	200K x 10	200K x 20	200K x 50	200K x 100	200K x 200	200K x 500
09	2-1/2	20K x 1	20K x 2	20K x 5	200K x 10	200K x 20	200K x 50
10	3-1/8	200K x 10	200K x 20	200K x 50	200K x 100	200K x 200	200K x 500
11	4	200K x 10	200K x 20	200K x 50	200K x 100	200K x 200	200K x 500
12	CC20/CC30	20K x1	20K x 2	20K x 5	200K x 10	200K x 20	200K x 50
13	Alley Weigh	2K x 0.1	2K x 0.2	2K x 0.5	20K x 1	20K x 2	20K x 5
14	CC30-3	20K x 1	20K x 2	20K x 5	200K x 10	200K x 20	200K x 50
15	Chute Weigh	20K x 1	20K x 2	20K x 5	200K x 10	200K x 20	200K x 50
16	CC-50	200K x 10	200K x 20	200K x 50	200K x 100	200K x 200	200K x 500
18	SPARE	20K x 1	20K x 2	20K x 5	200K x 10	200K x 20	200K x 50
20	1-digi	2K x 0.1	2K x 0.2	2K x 0.5	20K x 1	20K x 2	20K x 5
21	1 POLY(DIGI)	20K x 1	20K x 2	20K x 5	200K x 10	200K x 20	200K x 50
22	1-7/8,2(DIGI)	20K x 1	20K x 2	20K x 5	200K x 10	200K x 20	200K x 50
23	2-1/8,2-1/2,2-7/8,3-3/4 (DIGI)	20K x 1	20K x 2	20K x 5	200K x 10	200K x 20	200K x 50
97	Custom Setting	200 x 0.01	200 x 0.02	200 x 0.05	2K x 0.1	2K x 0.2	2K x 0.5
98	Custom Setting	20K x 1	20K x 2	20K x 5	200K x 10	200K x 20	200K x 50
99	Custom Setting	200K x 100	200K x 200	200K x 500			
	3rd Digit	0	1	2	3	4	5

The third digit of the CCN is found in Table 8.2.

Table 8.2 Table for 4th CCN Digit

4th Digit	Print Formats
0	G
1	GTN
2	G w/ TD
3	GTN w/TD (STD)
4	CSV-G
5	CSV-GTN
6	CSV-G w/TD
7	CSV-GTN w/TD
8	Displayed Wt.
9	Displayed Wt. w/TD

The fourth digit of the CCN is found in Table 8.3.

Table 8.3 Table for 5th CCN Digit

5th Digit	units	Auto-Loc	Auto-Acc
0	Lb	Off	Off
1	Lb	Off	On
2	Lb	On	Off
3	Lb	On	On
4	Kg	Off	Off
5	Kg	Off	On
6	Kg	On	Off
7	Kg	On	On

Once you have your five digit number, enter it as follows:

1. From **CONFIG**, press **PRINT/SELECT**...

Current code number is shown.



If attempting to enter an invalid number display will show CAN't and return to CONFIG.

2. Use the numeric entry procedure to enter the new number and press the **PRINT/SELECT** key when finished.

CONFIG is shown.

3. Press the **G/N** key...

Indicator returns to the G/N weighing mode.

8.1.3 Configuration Code Numbers for Common applications:

TMR MIXERS:

2 1/8 inch calibration weigh bar	20,000 x 5 lb	(5230)
2 1/2 inch calibration weigh bar	200,000 x 10	(9330)
2 1/4D calibration weigh bar	200,000 x 10 lb	(7330)
CC-30 Compression Cell	200,000 x 10 lb	(14330)

GRAIN CARTS:

2 1/4D calibration weigh bar	200,000 x 20 lb	(7430)
CC-30 Compression Cell	200,000 x 20 lb	(14430)

LIVESTOCK:

2 1/8 inch calibration weigh bar	20,000 x 1 lb	(5030)
Chute Weigh System	20,000 x 1 lb	(15030)
Alley Weigh System	2,000 x 1 lb	(13330)

If it is impossible to know exactly which weigh bars are on the scale system, try one of the recommended Configuration Code Numbers and keep entering code numbers until the scale appears to be weighing properly. (See section below entitled: Entering A New Configuration Code Number)

After several attempts at a code number, if the scale still does not weigh properly please consider the following:

- Contact your dealer or distributor where the scale was purchased
- Access the Avery Weigh-Tronix website at www.agscales.com for more debugging tips
- Contact the Avery Weigh-Tronix service department at 1-800-458-7062 for assistance

8.1.4 Configuring the Model 640 for Other Brand Weigh Bars and Loadcells

The Model 640 will work with any brand of strain gage based weigh bar or load cell. Once the system is installed, the Model 640 will then need to be calibrated. This can be accomplished by placing a known weight on the scale and then calculating the sensitivity output based on information from the weigh bar or load cell that can be directly entered into the indicator.

In the case of other brands other than Avery Weigh-Tronix, two configuration code numbers must be entered into the Model 640:

- Configuration Code Number
- Custom Calibration Number

As discussed previously, the Configuration Code Number for a custom setting can be derived by referencing Tables 8.1 through 8.3 to determine the Configuration Code Number and using codes 97XXX through 99XXX, then a CUSTOM CALIBRATION number will need to be calculated. Enter the Configuration number that comes closest to how the scale needs to be configured.

Now a Custom Calibration Number needs to be calculated. This can be derived by two methods; either get the information from the weigh bars that are being use as shown here:

Example 1:

Need to calibrate to 4 weigh bars with the following information:

1 weigh bar 2.0 mV/V = 5,000 lb

Therefore 4 weigh bars would be 2.0 mV/V = 20,000 lb for the system

CUSTOM calibration number needs to be weight value at .4mV/V or 4,000 lb.

OR

The other method is to first enter in the Configuration Code Number (97XXX through 99XXX) and then place a known weight on the scale. Record that weight and then figure the scale factor difference from the known weight and the displayed weight. Then this factor needs to be multiplied by the current CUSTOM number to calculate the new CUSTOM number.

Example 2:

Current CUSTOM configuration Code = 4000

To access CUSTOM number, reference the next section <blue><italic>Viewing/
Entering a Custom Calibration Number

Known Weight Applied 15,000

M640 Displayed Weight 10,000

Known Weight/ Displayed Weight 1.5000

(New CUSTOM #) = (Current CUSTOM #) x (Calibration Factor)

6000 = 4000 x 1.5

Therefore go to the CUSTOM CALIBRATION setting in the SETUP menu and change as needed.

8.1.5 Viewing/Entering a Custom Calibration Number

EXAMPLE: System capacity of 2 mV/v at 20000 lb, or .4 mv/v=4000 lb

The custom number as stated would be the weight value at 0.4 mv/v or as in this example 4000 lb.



You cannot access the CUSTOM number until the CCN, starting with 97XXX through 99XXX, has been entered.

1. From the **CONFIG** display, press **HOLD/MENU** once...

CUSTOM is shown

2. Press the **PRINT/SELECT** key...

Current weight is shown. Default value of custom = 20000, or 0.4 mv/v at 20,000 lb.

3. Use the numeric entry procedure to enter 4000...

4000 is shown.

4. Press the **PRINT/SELECT** key...

CUSTOM is shown.

5. Press the **G/N** key...

Indicator returns to the G/N weighing mode.

8.2 How to Configure Filtering

If you need to adjust the filtering on your Model 640 to counteract excessive movement or vibration on the scale system, follow these steps to access the FILTER menu item of the Setup menu and make needed changes.

1. Access the Setup menu from the G/N mode. To do so, press and hold the **HOLD/MENU** key for three beeps (3 seconds), then release...

SET.PAS is displayed.

2. Use the numeric entry procedure, see note below, to enter the password **640**. Press **PRINT/SELECT** to accept it...

640 is shown



Numeric Entry Procedure



Press this key to enter a value on the screen and increment the value being entered.



Press this key to decrement the numeric value being entered.



Press this key to move the numeric entry cursor one position to the right.

-
3. Press **PRINT/SELECT** once more...

CONFIG is displayed.

4. Repeatedly press the **HOLD/MENU** key until...

FILTER is displayed. There are two parts to filtering; Constant and Window. How to set these is explained below. How they affect weighing is explained in the *Filtering* note below.

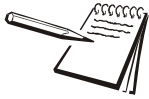

Filtering:

Default settings; *CONST=2, WINDOW=0*

If the value for the constant (CONST) = OFF, the filtering is disabled. If a value for CONST is entered, filtering is ON and you must also enter a WINDOW value. Set the CONST number small for small vibration problems and higher for more dampening effect.

The WINDOW threshold parameter defines a weight window that enables the filtering. The recommended value of 0 is the default, which means the filtering is engaged all the time.

Example: A WINDOW setting of 10 means a weight change over 10 pounds occurring during the display update time will disable the filter until the weight change during the sample time remains within 10 lbs.

5. Press the **PRINT/SELECT** key twice...

The current CONSTANT value is shown. Press the **HOLD/MENU** key to increase the value. Increasing this value causes the indicator to ignore increasing amounts of weight change on the scale. This means small changes can be ignored at a relatively small Constant value. To filter larger changes out, choose a larger Constant value. (Choices are OFF to 10, Default=2)

6. When the value you want to try is displayed, press the **PRINT/SELECT** key...

Your choice is selected and **CONST** is displayed.

7. Press the **HOLD/MENU** key...

WINDOW is displayed. This is where you will set the threshold window of the filter parameter. You can enter 0 to full capacity.

8. Press the **PRINT/SELECT** key...

Current setting for the threshold window is displayed.

9. Use the numeric entry procedure to enter a new value. Press the **PRINT/SELECT** key to accept it...

WINDOW is displayed.

10. Repeatedly press the **G/N** key until you return to the gross weighing mode.

Check the function of the indicator. If the weight display does not act in a manner to your liking, repeat steps 1 through 9 until the indicator functions as desired.

9 Appendix: Troubleshooting

If problems are encountered in the operation of the Model 640 scale system, read through these troubleshooting steps and perform those that are appropriate. This information will assist in correcting any of the following situations:

- *Power ON Problems on page 62*
- *Indicator +/- RANGE Problem on page 63*
- *Indicator Over or Under Capacity Problem on page 64*
- *Inaccurate Weight Readings on page 64*
- *Drifting Weight Readings on page 64*
- *How to Get Service Repairs on page 65*

9.1 Power ON Problems

If after applying power to the indicator it does not power on, check the following items and then try to power on after each step.

1. **Check Input Voltage:** Required voltage into the indicator is 10-17 volts negative ground. If the voltage is between 9-10 volts the indicator will alternate between **LOW.BAT** and appropriate mode. The indicator will automatically turn off if the voltage drops below 9 volts for more than five seconds. Make sure to check the connections for corrosion, and or bent pins and reconnect the power source. Also inspect the power cable for possible damage Again the unit can be powered directly from a 12VDC battery or a 120/240 VAC power transformer.



WARNING: You must disconnect power from indicator before charging or jump starting a battery.

If using a standard Avery Weigh-Tronix battery power cable, connect the BLACK wire to Ground and the WHITE wire to +12VDC.

Always disconnect all cables connecting to the indicator before welding on any OEM equipment. If not damage from high currents may cause internal damage.

2. **Internal Fuse:** A 3.15 Amp fuse is internal on the PC board, replace with Avery Weigh-Tronix style fuse or equivalent (AWT P/N 48561-0190). Make sure the new fuse is the proper size. Using a fuse with too high of a current rating can cause costly damage to the indicator and will void your warranty. The fuse is soldered directly to the main board and should be replaced by a certified scale technician.

3. **Internal 3 volt coin cell battery:** The Model 640 has an internal coin cell battery which provides backup power for retention of the time and date, and the 100 memory channel accumulator data. During normal operation, when power is turned off all this information is saved. After 4-5 years the coin cell battery will be drained. When this happens and the unit is turned off, the information will be lost and the indicator will no longer turn on. When this occurs, you must replace the coin cell battery to resume normal indicator function.

To access the battery, remove the front screws on the 640/XL or the back screws on a 640M and replace the coin cell battery (B1) on the main electronic board. See location in Figure 9.1.

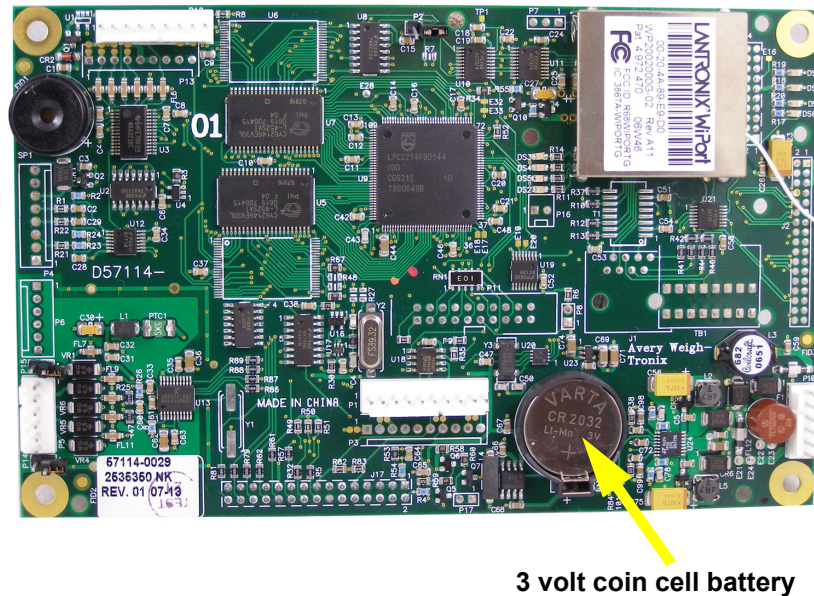

Figure 9.1 Coin cell battery location on the main board



Be sure to replace the battery(b1) with the same or equivalent type recommended by the manufacturer. Avery Weigh-Tronix PN of the battery is 60207-0013.

4. **Check All Incoming Cables:** Now try pressing the **ON/OFF** key and see if the M640 will turn on. If not disconnect all incoming cables and try one last time, if it still will not turn on there is a definite problem with the M640. Please send it to a certified service center or return to Avery Weigh-Tronix.

9.2 Indicator +/- RANGE Problem

An over Ranged Indicator is represented by either **+/- RANGE** on the display, and is typical until weigh bars or load cells are actually plugged into the unit. Once a weight sensor is plugged in, actual readings will be displayed and the indicator can be zeroed. The +/- RANGE represents more than +/- 8 mv/v input.

9.3 Indicator Over or Under Capacity Problem

This situation occurs when the input from the weigh bars or load sensors exceed the capacity of the Model 640.

1. If indicator shows either upper or lower dashes on the display, press **ZERO/CLEAR** when the scale is empty to establish a zero weight readings.
2. If the unit still does not zero, then it is most likely a problem with a weigh bar. Plug one weigh bar in at a time and press the **ZERO/CLEAR** key, and when a weigh bar is found that will not zero from the under or overcapacity screen then it is probably a defective weigh bar. Check for cable damage and fix or replace weigh bar or sensor as needed or repair immediately.

9.4 Inaccurate Weight Readings

1. Please check and reference Appendix X Quick Programming Guide and see if the Configuration Code Number (CCN) is properly entered for the scale application. If not known please consult dealer or distributor of final OEM product for assistance.
2. If Configuration Code Number (CCN) is entered properly do a visual inspection of the scale system and check for:
 - Cable Damage to Weigh Bar cables or junction box cable
 - Make sure the supporting structure and weighing structure do not touch at any other point except at the weigh bars.
3. Next if the scale is still not weighing properly, check for faulty weigh bars as follows:
 - Position a person or heavy object on the scale system above each weigh bar, one weigh bar at a time, and compare the weight readings.
 - All the readings should be nearly identical to each other. One reading that is significantly different from the others is probably defective. Replace as necessary.

9.5 Drifting Weight Readings

1. If weight readings drift, disconnect weigh bars and plug one bar in at a time until the bar that is plugged in makes the readings drift around considerably. The last weigh bar plugged in that makes this happen is probably the defective weigh bar. Again if all bars are unplugged the indicator will show **+/- RANGE**.
2. If weigh bars are plugged into a J-box and none of the weigh bars will stabilize the indicator then either the indicator is faulty or the junction box interface cable is faulty.

9.6 Loss of Data: Time & Date or Memory channels

The Model 640 has an internal coin cell battery which provides backup power for retention of the time and date, and the 100 memory channel accumulator data. During normal operation, when power is turned off all this information is saved. After 4-5 years the coin cell battery will be drained. When this happens and the unit is turned off, the information will be lost and the indicator will no longer turn on. When this occurs, you must replace the coin cell battery to resume normal indicator function.

To access the battery, remove the front screws on the 640/XL or the back screws on a 640M and replace the coin cell battery (B1) on the main electronic board. See location in Figure 9.1.



Be sure to replace the battery(b1) with the same or equivalent type recommended by the manufacturer. Avery Weigh-Tronix PN of the battery is 60207-0013.

9.7 How to Get Service Repairs

If the indicator is defective or needs service, contact your supplier, or send the equipment prepaid to:

Service Department
 Avery Weigh-Tronix
 1000 Armstrong Drive
 Fairmont, MN 56031
 PHONE #: 1-800-458-7062 M-F 8:00 AM – 5:00 PM (CST)

Please include:

Name and address
 Supplier name and address
 Date of Purchase
 An informal note explaining the problem

If possible, include the make and model number of the OEM equipment the Model 640 is used on.

Standard Scale & Supply Company
25421 Glendale Avenue
Redford, MI 48239
313-255-6700
www.standardscale.com

