

M3060 Indicator



User Instructions

© Avery Weigh-Tronix, LLC 2010. All rights reserved.

No part of this publication may be reproduced, stored in an electronic retrieval system, or transmitted in any form or by any means, electronic, mechanical, photocopying, recording or otherwise without the prior written consent of the copyright owner, or as permitted by law or under license. Full acknowledgment of the source must be given. Avery Weigh-Tronix is a registered trade mark of the Avery Weigh-Tronix, LLC. This publication was correct at the time of going to print however, Avery Weigh-Tronix, LLC reserves the right to alter without notice the specification, design, price or conditions of supply of any product or service at any time.

All third party brands and product names used within this document are trademarks or registered trademarks of their respective holders.

Quick Start

If your M3060 is already installed and you are only doing simple weighing such as gross and net weighing, you may only need this quick start. Detailed operating and installation instructions are included in the body of this manual.

Turn on the M3060

1. Press and hold the **ON/OFF** key until the red light above the key illuminates.



Figure 2.1 On/Off Key

The logo screen appears



Figure 2.2 Logo Screen shown during startup

When the indicator finishes loading, a screen similar to 2.3 appears.



Figure 2.3 Standard Application Screen

Simple Weighing

1. Turn the indicator on.
2. Press the **G/N** key on the screen to select either gross or net weighing.
3. Remove all materials from the scale.
4. Press the **ZERO** key on the screen.
5. If using net weighing, place the container on the scale and press **TARE**. For gross weighing, omit this step.
6. Place the item to weigh on the scale or in the container

Turn off the M3060

To turn the indicator off, press and hold the power key until prompted to release the key.

Table of Contents

	<i>page</i>
Quick Start	3
Turn on the M3060	3
Simple Weighing	3
Turn off the M3060	3
Chapter 1 General information and warnings	7
About this manual	7
Text conventions	7
Special messages	7
Installation	8
Safe handling of equipment with batteries	8
Routine maintenance	8
Cleaning the machine	9
Training	9
Sharp objects	9
FCC and EMC declarations of compliance	9
Chapter 2 Introduction to the M3060	11
Front Panel and Keys	11
Display Symbols, Icons and Messages	12
Rear Panel of the M3060	13
Chapter 3 Installation	14
Mounting with RAM® Mount	14
Mounting with Desktop Mount	17
Routing the Scale Interface Cable	18
Power Connections - Battery	19
Power Connections - AC	22
Optional Communications Connections	22
Additional Connectors	23
Chapter 4 Operation	24
Powering the M3060	24
Simple Weighing	25
Gross/Tare/Net (GTN) Weighing (single tare)	25
Loading or Unloading Consecutive Net Amounts	26
Using HOLD	27
Maintain Weight for Mobile Systems	28
Maintain Weight after Power Off	28
Printing	29
Chapter 5 Setup and Diagnostics	30
Entering Alphanumeric Values	30
Menus and Modules	32
Accessing the Menus	33
<i>User Settings</i> Module	34
Set Date and Time	34
To set the time	34
To set the date	35
Set Speaker Volume	36
View Service Contact Information	36
Seal Switch	36

<i>About M3060 Module</i>	37
<i>Audit Trail Viewer Module</i>	37
<i>Diagnostics Manager Module</i>	38
Communications	39
Test Communications Ports	39
View Ethernet Settings	40
View WiFi Data	41
Test Keypad	42
Test Touchscreen	42
View Raw Counts	43
Trips	43
Seal Switch	43
Over/Under Load Viewer	44
Menu Maps	45
Chapter 6 Extras	46
Configuration Codes	46
Additional Hardware	48

1 General information and warnings

1.1 About this manual

This manual is divided into chapters by the chapter number and the large text at the top of a page. Subsections are labeled as shown by the 1 and 1.1 headings shown above. The names of the chapter and the next subsection level appear at the top of alternating pages of the manual to remind you of where you are in the manual. The manual name and page numbers appear at the bottom of the pages.

1.1.1 Text conventions

Key names are shown in **bold** and reflect the case of the key being described. This applies to hard keys and onscreen or soft keys.

Displayed messages appear in ***bold italic*** type and reflect the case of the displayed message.

1.1.2 Special messages

Examples of special messages you will see in this manual are defined below. The signal words have specific meanings to alert you to additional information or the relative level of hazard.



ELECTRICAL WARNING!
THIS IS AN ELECTRICAL WARNING SYMBOL.
ELECTRICAL WARNINGS MEAN THAT FAILURE TO FOLLOW SPECIFIC PRACTICES OR PROCEDURES MAY RESULT IN ELECTROCUTION, ARC BURNS, EXPLOSIONS OR OTHER HAZARDS THAT MAY CAUSE INJURY OR DEATH.



CAUTION!
This is a Caution symbol.
Cautions give information about procedures that, if not observed, could result in damage to equipment or corruption to and loss of data.



NOTE: *This is a Note symbol. Notes give additional and important information, hints and tips that help you to use your product.*

1.2 Installation



DANGER: RISK OF ELECTRICAL SHOCK. NO USER SERVICEABLE PARTS. REFER TO QUALIFIED SERVICE PERSONNEL FOR SERVICE.

1.2.1 Safe handling of equipment with batteries



CAUTION: Danger of explosion if battery is incorrectly replaced. Replace only with the same or equivalent type recommended by the manufacturer. Dispose of used batteries according to the manufacturer's instructions.

ATTENTION: Il y a danger d'explosion s'il y a remplacement incorrect de la batterie, remplacer uniquement avec une batterie du même type ou d'un type équivalent recommandé par le constructeur. Mettre au rebut les batteries usagées conformément aux instructions du fabricant.

1.3 Routine maintenance



IMPORTANT: This equipment must be routinely checked for proper operation and calibration. Application and usage will determine the frequency of calibration required for safe operation.

Always turn off the machine and isolate from the power supply before starting any routine maintenance to avoid the possibility of electric shock.

Make sure that it is placed securely on a flat and level surface.



CAUTION: Do not weld on or near the M3060 or any part of the scale system such as Weigh Bars. Excessive heat and / or high currents may cause internal damage. Physically remove the M3060 from any equipment it is mounted to and disconnect it from the power source. Make ground connection as far away from any scale part (cables, Weigh Bar, etc.) as possible.

1.4 Cleaning the machine

Table 1.1 Cleaning DOs and DON'Ts



DO	DO NOT
Wipe down the outside of standard products with a clean cloth, moistened with water and a small amount of mild detergent	Attempt to clean the inside of the machine
	Use harsh abrasives, solvents, scouring cleaners or alkaline cleaning solutions
Spray the cloth when using a proprietary cleaning fluid	Spray any liquid directly on to the display windows

1.5 Training

Do not attempt to operate or complete any procedure on a machine unless you have received the appropriate training or read the instruction books.

To avoid the risk of RSI (Repetitive Strain Injury), place the machine on a surface which is ergonomically satisfactory to the user. Take frequent breaks during prolonged usage.

1.6 Sharp objects

Do not use sharp objects such as screwdrivers or long fingernails to operate the keys.

1.7 FCC and EMC declarations of compliance

United States

This equipment has been tested and found to comply with the limits for a Class A digital device, pursuant to Part 15 of the FCC Rules. These limits are designed to provide reasonable protection against harmful interference when the equipment is operated in a commercial environment. This equipment generates, uses, and can radiate radio frequency energy and, if not installed and used in accordance with the instruction manual, may cause harmful interference to radio communications. Operation of this equipment in a residential area is likely to cause harmful interference in which case the user will be required to correct the interference at his own expense.

European Countries

WARNING: This is a Class A product. In a domestic environment, this product may cause radio interference in which the user may be required to take adequate measures.

Avery Weigh-Tronix

Foundry Lane, Smethwick, West Midlands B66 2LP, England

	Declaration of Conformity Verklaring van Overeenstemming Déclaration de Conformité	Konformitätserklärung Dichiarazione di conformità Declaración de Conformidad
--	---	---

Manufacturer	Avery Weigh-Tronix Limited
Type	M3060
corresponds to the requirements of the following EC directives:	
EMC Directive	2004/108/EC
Low Voltage Directive	2006/95/EC
The applicable harmonised standards are:	
EN 60950-1 : 2006	EN 61000-6-1 : 2007 EN 61000-6-3 : 2007
<small>Avery Weigh-Tronix Limited Reg. Office: Foundry Lane, Smethwick, West Midlands B66 2LP, England. Registered in England No: 595129</small>	

Fabrikant	Avery Weigh-Tronix Limited
Type	M3060
is in overeenstemming met de voorschriften van de volgende EG richtlijnen:	
EMC Richtlijn	2004/108/EC
Laagspanningsrichtlijn	2006/95/EC
Toegepaste geharmoniseerde normen:	
EN 60950-1 : 2006	EN 61000-6-1 : 2007 EN 61000-6-3 : 2007
<small>Avery Weigh-Tronix Limited Reg. Office: Foundry Lane, Smethwick, West Midlands B66 2LP, England. Registered in England No: 595129</small>	

Fabricant	Avery Weigh-Tronix Limited
Type	M3060
correspond aux exigences des directives CE suivantes :	
Directive CEM	2004/108/EC
Directive Basse Tension	2006/95/EC
Les normes harmonisées applicables sont :	
EN 60950-1 : 2006	EN 61000-6-1 : 2007 EN 61000-6-3 : 2007
<small>Avery Weigh-Tronix Limited Reg. Office: Foundry Lane, Smethwick, West Midlands B66 2LP, England. Registered in England No: 595129</small>	

Hersteller	Avery Weigh-Tronix Limited
Typ	M3060
entspricht den Anforderungen folgender EG-Richtlinien:	
EMV-Richtlinie	2004/108/EC
Niederspannungs Richtlinie	2006/95/EC
Die angewendeten harmonisierten Normen sind:	
EN 60950-1 : 2006	EN 61000-6-1 : 2007 EN 61000-6-3 : 2007
<small>Avery Weigh-Tronix Limited Reg. Office: Foundry Lane, Smethwick, West Midlands B66 2LP, England. Registered in England No: 595129</small>	

Produttore	Avery Weigh-Tronix Limited
Modello	M3060
è conforme alle caratteristiche previste dalle seguenti direttive CE:	
Normativa EMC	2004/108/EC
Normativa per la bassa tensione	2006/95/EC
Le norme standard armonizzate e nazionali applicate sono:	
EN 60950-1 : 2006	EN 61000-6-1 : 2007 EN 61000-6-3 : 2007
<small>Avery Weigh-Tronix Limited Reg. Office: Foundry Lane, Smethwick, West Midlands B66 2LP, England. Registered in England No: 595129</small>	

Fabricante	Avery Weigh-Tronix Limited
Tipo	M3060
conforme a las exigencias de las siguientes directivas CE:	
Directiva CME	2004/108/EC
Directiva de baja tensión	2006/95/EC
Las normas armonizadas en vigor son:	
EN 60950-1 : 2006	EN 61000-6-1 : 2007 EN 61000-6-3 : 2007
<small>Avery Weigh-Tronix Limited Reg. Office: Foundry Lane, Smethwick, West Midlands B66 2LP, England. Registered in England No: 595129</small>	

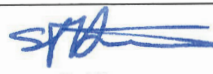
Signature/Name Handtekening/Naam Signature/Nom Unterschrift/Name Firma/Nome Firma/Nombre	 S. Hine Head of R & D (UK)	Authorised signatory for Avery Weigh-Tronix Limited Namens van Avery Weigh-Tronix Limited Signataire autorisé d'Avery Weigh-Tronix Limited Unterschriftsberechtigter für Avery Weigh-Tronix Limited Firmatario autorizzato per Avery Weigh-Tronix Limited Firmante autorizado para Avery Weigh-Tronix Limited	Date Datum Date Datum Data Fecha
			20 April 2010

2 Introduction to the M3060

The M3060 indicator is a programmable, customizable weight indicator with touchscreen. It allows the operator to view and store weight transactions or process information and mounts near the operator for easy use.

This manual covers the installation and general operation of the M3060 with the standard application. Additional custom applications are available from leading agricultural software providers. Contact your Avery Weigh-Tronix representative or visit www.agscales.com for more information.

2.1 Front Panel and Keys

The M3060, shown in Figure 2.1, has four keys on the front panel and a full color display with touch sensitive screen. The touch sensitive buttons on the bottom of the display work the same as traditional hard keys.

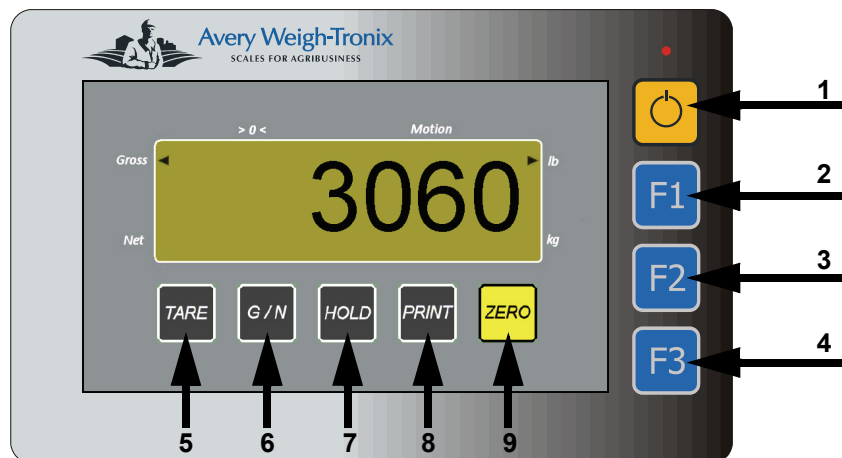

Figure 2.1 M3060 front panel

The chart below defines each of the keys shown in Figure 2.1

Reference	Key	Description
1	On/Off	Turn the indicator on and off.
2	F1	Press and hold the F1 key to access the password input screen. This is how you enter the menu system. This key is also used to toggle between upper case and lower case characters on the keys when alpha entry is allowed. For instructions on using the alphanumeric touchscreen, see Entering Alphanumeric Values on page 21 .
3	F2	The function of this key varies, depending on your application.
4	F3	The function of this key varies, depending on your application.

Reference	Key	Description
5	TARE	Press TARE to tare the weight on the scale for net weighing.
6	G/N	Press G/N to toggle between gross and net weighing modes.
7	HOLD	Press HOLD to hold a displayed weight. The weight is retained in memory in case the indicator is turned off. When powered up again, the held weight will display. Press HOLD again to release the hold mode.
8	PRINT	Press PRINT to send data to an attached printer.
9	ZERO	Press ZERO to zero the gross or net weight.

2.2 Display Symbols, Icons and Messages

Figure 2.2 shows the standard application screen with all the annunciators illuminated. These items and other display messages are explained below.

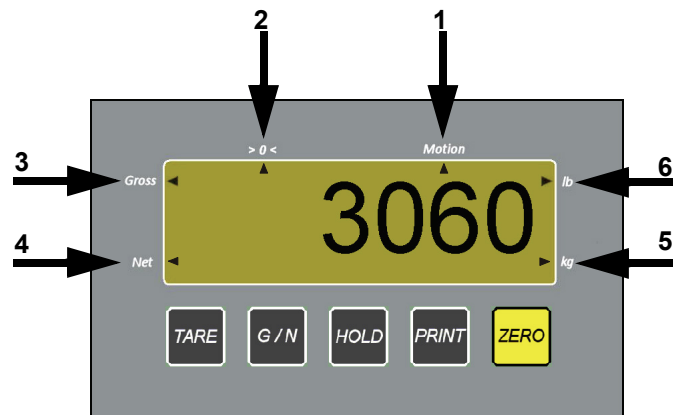

Figure 2.2 Standard Application with all annunciators and touch keys



The screen shown in Figure 2.2 is for illustration purposes only. You would not typically see ALL the annunciators at once.

The standard annunciators are defined below.

Reference	Description
1	When the arrow points to this annunciator, the weight is unstable. This will disappear when the weight is stable. Transactions and scale functions will only operate when the scale is stable.
2	When the arrow points to this annunciator, the scale is at center of zero.
3	When the arrow points to this annunciator, the indicator is in gross weighing mode.
4	When the arrow points to this annunciator, the indicator is in net weighing mode.
5	When the arrow points to this annunciator, the unit of measure is kilograms.
6	When the arrow points to this annunciator, the unit of measure is pounds.

You may also see the following annunciators or onscreen messages in various other screens.

BUSY	At various times you will see popup boxes showing the system is busy. These will disappear after the process is complete.
~	This symbol may appear in some menu screens and is the same as the arrow pointing to Motion .
UNDER LOAD	Scale is below the configured underload range.
-----	A series of five dashes at the bottom of the display indicates the scale is below the configured underload range (same as UNDER LOAD).
OVER LOAD	Scale is above the configured overload range.
-----	A series of five dashes at the top of the display indicates the scale is above the configured overload range (same as OVER LOAD).
NO ADC	No communication with the analog card.
>0<	Scale is at center of zero. (Same as arrow pointing at >0<).
lb/kg /gram/oz/ custom	The current unit of measure.
Gross or Net	Indicates current scale mode; Gross weighing or Net weighing. This is the same as the arrow pointing to Gross or Net .

2.3 Rear Panel of the M3060

The M3060 connectors are shown as they appear on the back of the indicator in Figure 2.3 and individually for greater detail following.

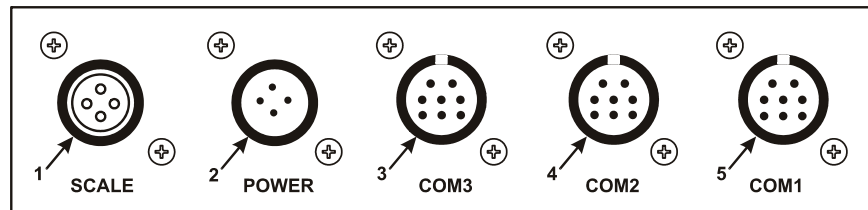

Reference	Description	Details
1	Scale Connector	Connect cable from junction box.
2	Power Connector	Connect power cable.
3	COM 3 Connector	Connect serial cable to peripheral. By default, this port is to connect to the XLR8 remote display.
4	COM 2 Connector	Connect serial cable to peripheral. By default, this port is to connect to the RD 40 RF.
5	COM 1 Connector	Connect serial cable to peripheral. By default, this port is for a printer connection.

Figure 2.3 M3060 connectors

Each of the connectors shown in Figure 2.3 is explained in detail on the following pages.

3 Installation

The M3060 is designed for use in multiple situations and there are many correct ways to install and mount the indicator. Use the steps and images below to help you as you move through the steps to connect the cables.

Contact your service representative for information on calibration procedures.



WARNING: Take all necessary safety precautions as you install the M3060. This includes wearing safety shoes, protective eyewear, and using proper tools.

3.1 Mounting with RAM® Mount

Avery Weigh-Tronix recommends using a RAM mount for mobile applications or areas of high vibration. A RAM mount kit (part number AWT05-504328) is available from your local Avery Weigh-Tronix provider.

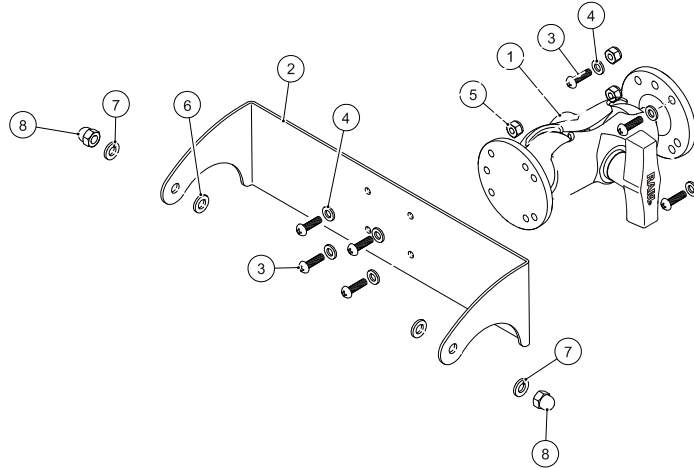
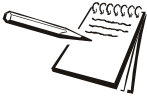

Figure 3.1 Ram Mount Kit Parts

Reference	Description	Qty
1	Ram Mount w/ 2 2.5 in. Bases & Ball Arm	1
2	Model 3060 Ram Mount Bracket	1
3	SST Pan Head Phillips Screw, 8-32x.750	8
4	SST Flat Washer #8	8
5	SST Hex Locking Nut, 8-32UNJC-3B	8
6	Zinc Plated CS Flat M6 Washer	2
7	Reg Locking 6mm Washer	2
8	M6 Nut	2

1. Clean and inspect the area where the indicator will be installed.



Place the instrument where it will not obstruct the operator's view or operation of other machinery.

2. Turn the handle until both bases can be easily removed as shown in [Figure 3.2](#).

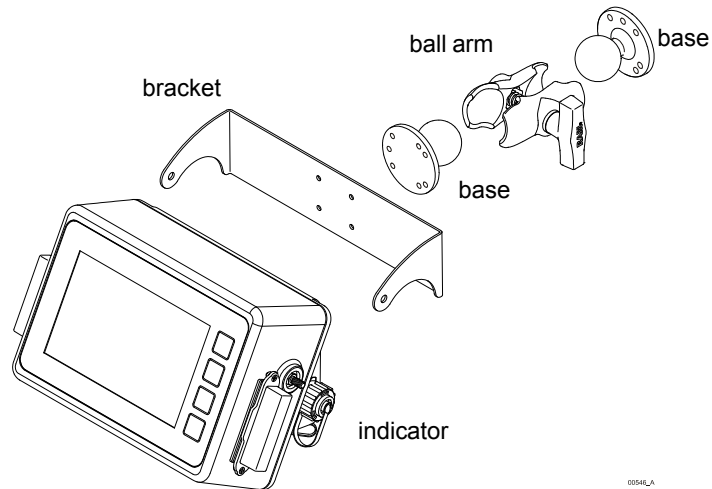

Figure 3.2 Bases Separated from Ball Arm

3. Mount one of the bases to the designated location.
4. Align the holes in the M3060 bracket with the holes on the other base.
5. Using the hardware included with the kit, attach the bracket to the base.
6. Attach the M3060 bracket to the indicator.

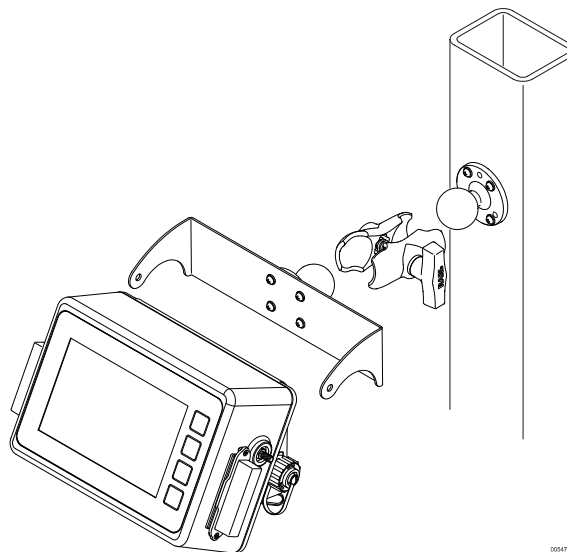

Figure 3.3 Bases Mounted

7. Tighten the acorn nuts to secure the bracket to the indicator.

8. Tighten the ball arm around the just enough to keep the assembly in place.
9. Insert the indicator and base assembly into the ball arm.

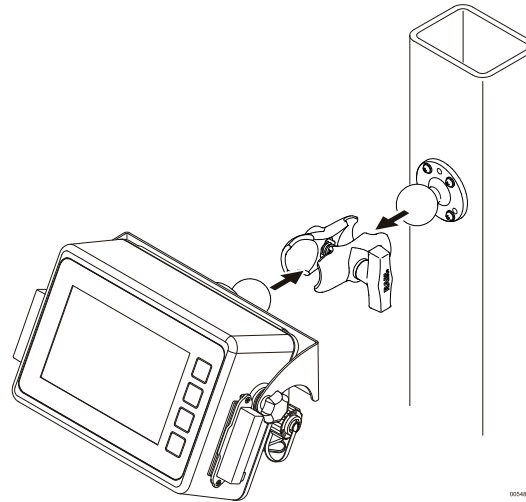

Figure 3.4 Mounting Assembly to Location

10. Adjust the angle of the indicator so that it is easy to use and view.
11. Tighten the ball arm to keep the whole assembly in place.
12. Proceed to [Routing the Scale Interface Cable](#).

3.2 Mounting with Desktop Mount

For applications where a RAM mount is not needed, a Desktop Mounting Kit (part number AWT05-504327) is available.

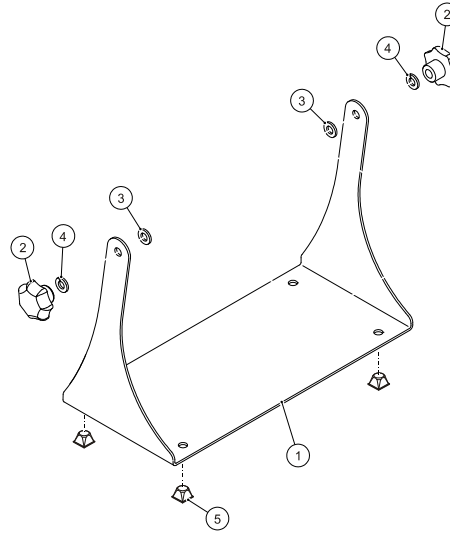

Figure 3.5 Desktop Mounting Kit

Reference	Description	Qty
1	Model 3060 Desktop Stand	1
2	Three Arm Knob	2
3	Flat M6 Zinc Plated CS Washer	2
4	Reg Lock 6mm Washer	2
5	Adhesive Backed Bumper	4

1. Choose a mounting location that is convenient and appropriate for the operation of the indicator.
2. Clean and inspect the area where the indicator will be installed.
3. Attach the four rubber feet to the bottom of the indicator, if necessary.

OR

3. Screw or bolt the mounting bracket to the location using the four holes in the mounting bracket

4. Attach the desktop mounting bracket to the M3060.

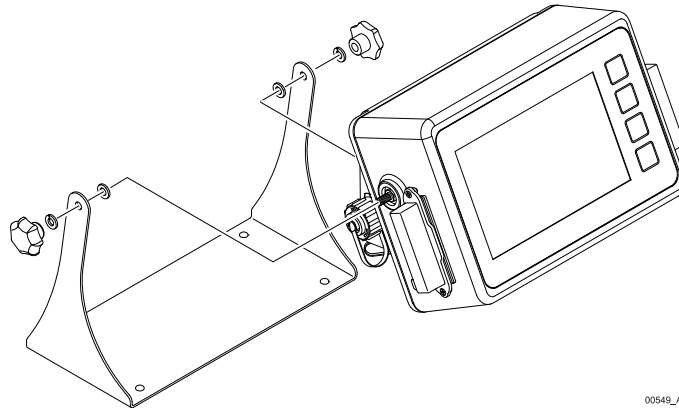

Figure 3.6 Mounting Bracket to Indicator

5. Adjust the indicator to the desired angle.
6. Tighten the bracket knobs finger-tight.

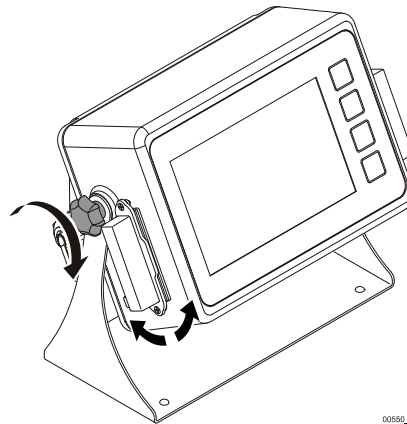

Figure 3.7 Tighten Knobs

7. Proceed to *Routing the Scale Interface Cable*.

3.3 Routing the Scale Interface Cable

The scale interface cable is the cable that runs from the junction box (j-box) to the indicator.



For systems with multiple Weigh Bars, you must use a junction box. For information on available junction boxes, contact your Avery Weigh-Tronix representative.

- Loosely connect the scale interface cable to the **SCALE** connector on the indicator.

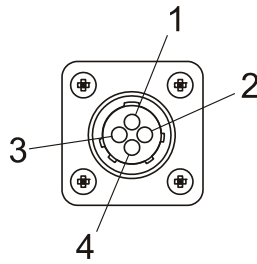
**Scale Connector**

Pin	Description
1	+ Excitation
2	- Bridge
3	+ Bridge
4	- Excitation

Figure 3.8 Scale Connector

- Run the cable from the indicator to the junction box, allowing some slack in the cable.
- Connect the other end of the scale interface cable to the junction box.
- Inspect the cable run and make sure that the cable is not pinched, kinked or in the way of moving parts or sharp objects.
- Tuck or cable tie the excess cable along the run as necessary.
- Tighten the connector at the indicator.

3.4 Power Connections - Battery

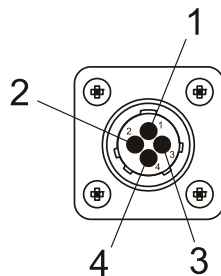
**Power Connector**

Pin	Description
1	+12 VDC
2	Ground
3	Output #1
4	Input #1

Available Power Cables

Part Number	Description
50474-0028	10 ft. power cable
50474-0036	20 ft. power cable
50474-0042	30 ft. power cable

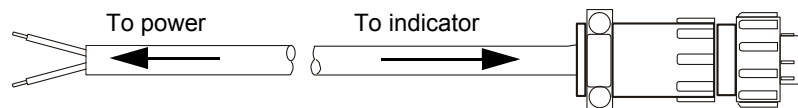
**Figure 3.9 Power Connector, Battery Cable**

- Disconnect the negative wire from the battery terminal before performing any electrical work.
- Loosely attach the connector end of the power cable to the M3060 indicator.

3. Route the cable to the desired power source connection point. If possible, run the power cable through existing holes and channels so that it will be out of the way and cannot be damaged by any moving parts. Be sure to keep the cable from running near a distributor cap, the spark plugs or wires, or the alternator on the motor. Keep the cable around the periphery of the engine compartment whenever possible.
4. Pull through all the slack in the cable and cable tie the power cable in appropriate places to hold it in place.
5. Disconnect the power connector from the back of the indicator.
6. Install the fuse kit between the power cable and the connection point by following these steps:
 - 6a. Cut the wire on the fuse holder where indicated in [Figure 3.10](#).

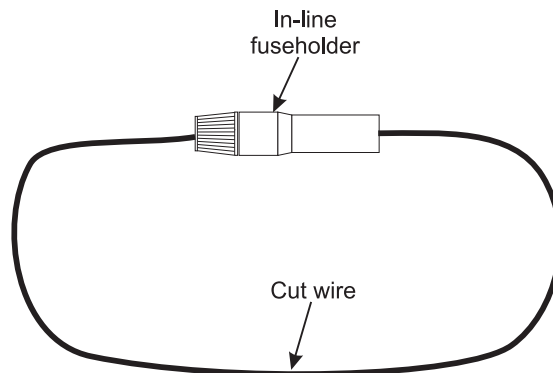

Figure 3.10 Fuse holder



CAUTION: *Non-approved power connections may damage equipment and void warranty.*

- 6b. Using the supplied butt splice connector (item 6 in figure [3.11](#)) and heat shrink tubing (item 5 in figure [3.11](#)), connect the wire from the fuse holder to the white wire from the power supply cable. The smaller diameter wire from the power cable should be inserted into the red striped end of the butt splice connector. Insert the wire from the fuse holder into the other end (no stripe) of the butt splice connector. The heat shrink tubing should be placed over the butt splice connector.
- 6c. Cut the heat shrink tubing (item 2 in figure [3.11](#)) in half and place one piece on the black wire from the power supply cable and one piece on the loose wire from the fuse holder.
- 6d. Crimp the ring terminals (item 1) onto the wires as shown in figure [3.11](#).
- 6e. Using a heat gun, shrink all three pieces of heat shrink tubing in place.

- 6f. If the battery terminals have bolts to which you can connect the ring terminals, do so. If not, skip to step 7. The ring terminal connected to the fuse holder should be attached to the positive (+) terminal. The ring terminal connected to the black wire should be attached to the negative (-) terminal. Skip to step 10.

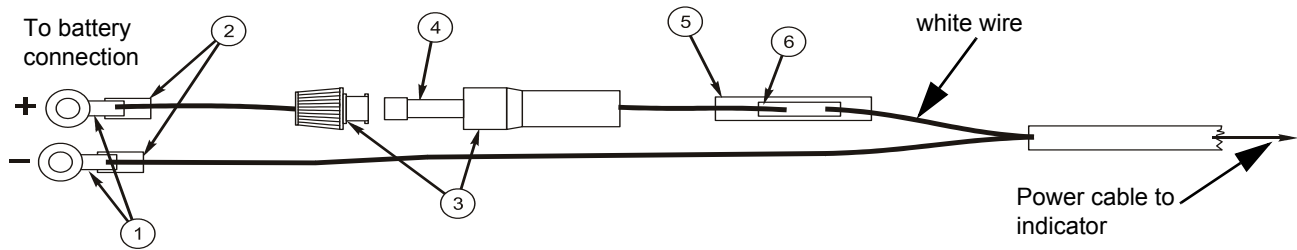

Figure 3.11 Fuse wiring



Item 4 in Figure 3.11 is the fuse. It is PN AWT25-500337 and is a 3AMP 3AG SLOW-BLOW FUSE.

7. Connect the white power cable as close as possible to the battery's positive voltage terminal without attaching it directly to the battery terminal. In other words, the first place the positive terminal is connected to is where you should tap in with the white power cable for the instrument.
8. Connect the black ground cable as close as possible to the battery's negative terminal without attaching it directly to the battery. In other words, the first place the negative terminal is connected to is where you should tap in with the black ground cable for the instrument. The chassis may not provide the proper ground potential. Check with the equipment manufacturer to determine if battery ground is isolated from chassis ground.
9. Tighten the AMP connector on the underside of the indicator. See figure 3.9.
10. Reconnect battery power.
11. Press and hold the **On/Off** key on the M3060 until the red light above the key comes on.
12. Check that the instrument powers on.

3.5 Power Connections - AC

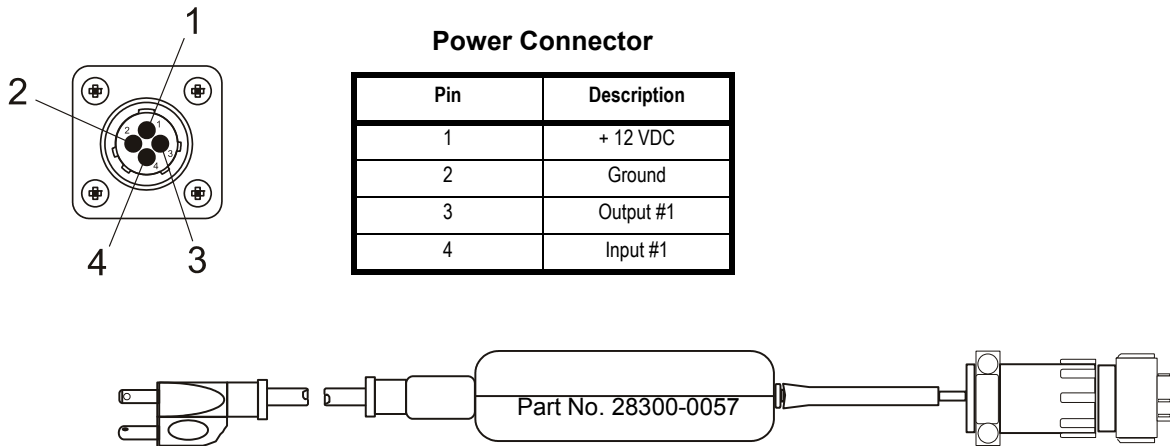

Figure 3.12 Power Connections, AC

For applications requiring AC power, follow these instructions.

1. Loosely attach the AC power adapter to the area near the outlet with a cable tie.
2. Route the cable from the electrical outlet to the indicator. If possible, run the power cable through existing channels or conduit so that it will be out of the way and cannot be damaged by any moving parts.
3. Inspect the cable run and make sure that the cable is not pinched, kinked or in the way of moving parts or sharp objects.
4. Tuck or cable tie the excess cable along the run as necessary.
5. Tighten the AMP connector on the underside of the indicator.
6. Plug the AC adapter in to the outlet.
7. Press and hold the **On/Off** key on the M3060 until the red light above the key comes on.
8. Check that the indicator powers on.

3.6 Optional Communications Connections

The M3060 comes with three serial communications (COM) ports which can be used for various peripheral equipment such as a the XLR-8 remote displays, printer, RM200 or other device. Use the following instructions for connecting a serial peripheral device to the M3060.

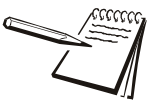

All COM ports on the M3060 indicator have the same pinouts as shown in [Figure 3.13](#). COM 1 is configured for a printer, COM 2 is configured for RM200 and COM 3 is configured for XLR-8 remote display. The default settings for each port are: 9600 Baud, 8 Data Bits, No Handshaking and 1 Stop Bit. Contact your Avery Weigh-Tronix representative if you need to change these settings.

1. Disconnect the indicator and peripheral device from the power source.
2. Loosely connect the communications cable (serial cable) to the required COM port.

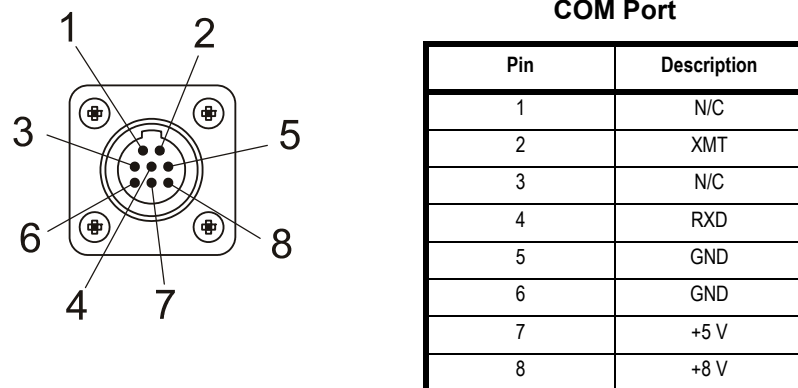

Figure 3.13 Sample COM Port

3. Route the serial cable to the peripheral device using existing channels or conduit whenever possible.
4. Connect the serial cable to the device.
5. Inspect the cable run and make sure that the cable is not pinched, kinked or in the way of moving parts or sharp objects.
6. Tighten the connector at the indicator.
7. Reconnect power to the indicator and device.
8. Press and hold the **On/Off** button on the M3060 until the red light comes on and the indicator powers on.



For a list of optional cables and serial devices, see [Additional Hardware on page 48](#).

3.6.1 Additional Connectors

The M3060 also has the following connectors:

- USB connector - located on one side of the back panel. Use the USB connector to connect a USB keyboard or jump drive.
- Ethernet connector - located on one side (opposite side of the USB connector) of the back panel. This port is application dependent.
- Two Compact Flash slots - one on either side of the main body of the indicator. These slots are application dependent.

Your scale is now installed and ready for use. If you have any questions during installation, please contact your local Avery Weigh-Tronix representative.

4 Operation

This section covers using the standard application.

4.1 Powering the M3060

To turn the indicator on, press and hold the **ON/OFF** key, shown below, until the red light above the key illuminates.



Figure 4.1 On/Off Key

The following screen appears



Figure 4.2 Logo Screen shown during startup

If a screen other than the one shown in [Figure 4.2](#), contact your local Avery Weigh-Tronix representative.



Normal indicator functions will be available after the indicator completes startup.

When the indicator finishes loading, a screen similar to [4.3](#) appears.

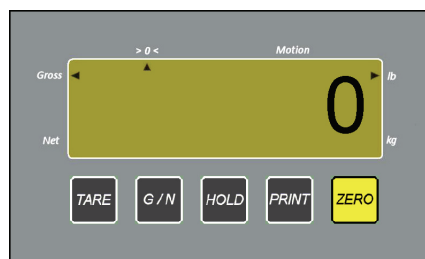

Figure 4.3 Standard Application Screen

1. To turn the indicator off, press and hold the **ON/OFF** key.
2. Release the **ON/OFF** key when the screen prompts you to release it.

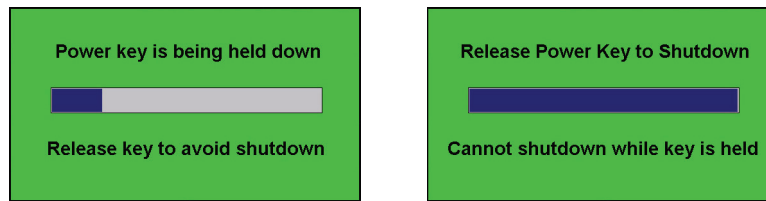

Figure 4.4 Shutdown Messages

4.2 Simple Weighing

1. With the indicator on, press the **G/N** key on the screen, if necessary, until the arrow points at **Gross**.
2. Remove all materials from the scale.
3. Press the **ZERO** key on the screen.
The weight reading changes to 0 and the system is zeroed.
4. Place the item to weigh on the scale.
5. The gross weight appears on screen.

4.3 Gross/Tare/Net (GTN) Weighing (single tare)

For GTN weighing (net weighing), follow these steps:

1. With the indicator on, press the **G/N** key on the screen, if necessary, until the arrow points at **Gross**.
2. Remove all material from the scale.
3. Press the **ZERO** key on the screen to zero the system.
4. Place material on the scale to be tared.

The gross weight of the material appears.

5. Press the **TARE** key on the screen.

The weight returns to zero and the arrow points to the **Net** annunciator.

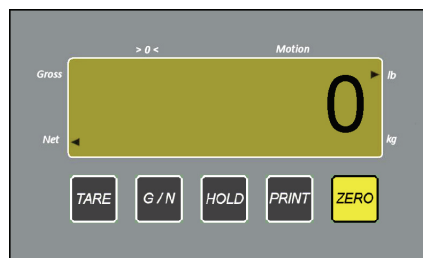

Figure 4.5 Net Weight at Zero

6. Place the material to weigh on the scale.

The net weight displays.

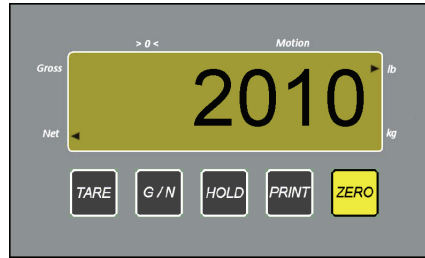

Figure 4.6 Net Weight of Weighed Item

7. Remove the material from the scale (leaving the tared item).

The weight returns to zero. The indicator remains in net weighing mode.

8. Repeat steps 6 and 7 for each weighing using the same tare.
9. When finished, press the **G/N** key on the screen to return to gross weighing mode.
10. Remove the tared material.
11. Press the **ZERO** key on the screen as necessary to zero the scale.

The tare weight is removed. You can repeat this process to weigh more material with a different tare weight.

4.4 Loading or Unloading Consecutive Net Amounts

This procedure allows the user to load or unload a series of net amounts and is ideal for TMR mixers, weigh carts, grain carts, etc. for viewing and recording net amounts of material loaded or unloaded.

1. With the indicator on and scale system empty, press the **G/N** key on the screen, if necessary, until the arrow points at **Gross**.
2. Press the **ZERO** key on the screen to zero the system.
3. Place the initial amount of material on the scale.
The gross weight of the material appears.
4. Press the **TARE** key on the screen.

The weight returns to zero and the arrow points to the **Net** annunciator.

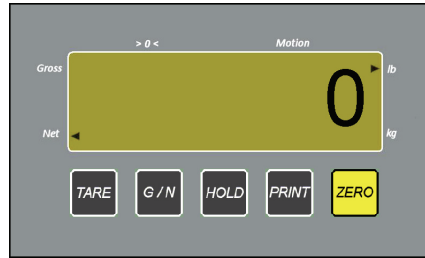

Figure 4.7 Net Weight at Zero

5. Load or unload material as necessary.

The net weight displays. If adding material, the net weight shows as a positive number. If unloading material, the net weight displays as a negative number.

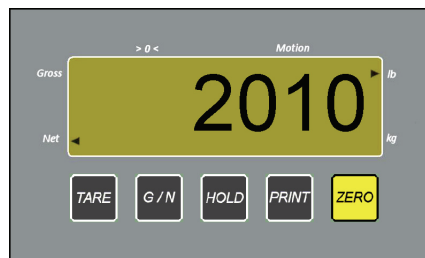

Figure 4.8 Net Weight of Material Added

6. When the display shows the correct amount, stop loading or unloading material.
7. Repeat steps 5 and 6 for each weighment using the same tare.

4.5 Using HOLD

Use the **HOLD** feature to prevent a zero shift from occurring on a portable scale system such as a mixer, weigh cart, grain cart, etc. or to maintain weight when the indicator is powered off.

4.5.1 Maintain Weight for Mobile Systems

1. Before activating **HOLD**, place the load on the scale.
2. Once the scale is loaded and the weight displays, press the **HOLD** key on the screen.

HOLD appears on the screen.



Figure 4.9 Sample Hold Screen

3. Move the system to the new loading or unloading location.
4. Press the **HOLD** key on the screen.
5. The weight from step 2 appears on screen.

4.5.2 Maintain Weight after Power Off

If you are finished using the scale for the day but there is still material on the scale, use these steps to prevent minimal weight shifts due to temperature changes or to remember the weight for when you resume the activity.

1. Verify that the material and any containers for the material are on the scale and that the weight is displaying properly.
2. Press the **HOLD** key on the screen.

HOLD appears on the screen.

3. Turn the system off.
4. When ready to resume the activity, turn the system on.

HOLD appears on the screen after the indicator finishes loading.

5. Press the **HOLD** key on the screen.
6. The weight from step 2 appears on screen.



HOLD works in both gross and net weighing. If you were using net weighing before turning the indicator off, when you turn it back on, the indicator will return to net weighing. The same is true for gross weighing.

4.6 Printing

If you have connected a printer to your M3060, you can quickly print the gross, tare and net weights with time and date by pressing the **PRINT** key on the screen when the weight is stable.

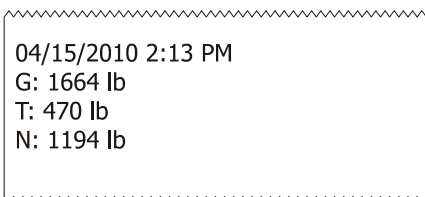

04/15/2010 2:13 PM
G: 1664 lb
T: 470 lb
N: 1194 lb

Figure 4.10 Sample Printout



The scale must return to zero and the weight must be stable before you can print again.

5 Setup and Diagnostics

This chapter covers the setup and diagnostics of the M3060.

5.1 Entering Alphanumeric Values

The alphanumeric entry screen appears often during setup and use of the M3060. This screen mimics a cell phone pad for numeric or text entry. Follow these steps to enter an alpha, numeric or alphanumeric value:



Figure 5.1 Alphanumeric entry screen (Password in this example)

1. Once the entry screen appears, you have 10 seconds (default) to start entering characters before the screen reverts to the previous screen.
2. Touch a blue button to enter the number, decimal or + / - sign. The number you enter appears by the blinking cursor at the top left of the display.



When you enter passwords, only asterisks () appear in place of the entered characters. An optional, attached USB keyboard can help make accurate entries.*

3. The cursor automatically advances to the next position any time you wait for two seconds or more.
4. If you repeatedly touch the same key before the cursor advances, the display shows each successive number or character on the key. For example: Press the **6** key three times in rapid succession and the **N** appears on screen.
5. If you want to enter the same number repeatedly, you must hesitate two seconds between key presses or, you can speed up this process by pressing the **Adv** key between each numeric key to force the cursor to advance to the next position.
6. Press the **F1** key to switch the alpha characters on the keys to lower case letters. See Figure 5.2. Press the **F1** key again to return the display to upper case letters. This works only if the entry screen allows alpha character entry. Some screens allow only numeric entry.



Figure 5.2 Lower case letters

7. Press the **Esc** key to exit and return to the previous screen. If you press the **Esc** key, the indicator will keep the previous value of the field that was being edited.
8. Press the **Clear** key to erase the last character entry or all highlighted characters.
9. Press the **Adv** key to advance the cursor to the next position.
10. When you are finished entering characters, press **Enter** to save the data.

5.2 Menus and Modules

The M3060 indicator has 2 password protected menus that give access to specific modules or areas of indicator function

MENU NAME	PASSWORD
User Management Menu	111
Diagnostic Management Menu	911

A module remains the same no matter which menu you access it from, except for minor exceptions noted in the overview and full descriptions.

		Menus	
		Password 111	Password 911
Modules		User Management Menu includes:	Diagnostic Management Menu includes:
	Audit Trail	✓	✓
	About M 3060	✓	✓
	User Settings	✓	✓
	Diagnostics Manager		✓

Figure 5.3 Menus and the modules they contain

Figure 5.3 shows a table explaining the module access granted by the two passwords. For a map of each of the menus, see page 45. Additional configuration functions are available to your Avery Weigh-Tronix representative in the service manual.

The following sections explain how to access each of the menus as well as detail each of the modules.



*Any time you exit a menu to return to normal operating mode, you are asked if you want to save any changes that have been made. You can choose **Yes**, **No**, or **Cancel**. Choose **Yes** to save changes and return to normal operation. Choose **No** to disregard any changes made while in the menu and return to normal operation. Press **Cancel** to stay in the menu.*

*The one exception to this is the Time and Date window. When you accept a new setting for time and date, that change takes place immediately and is unaffected by the **Yes**, **No**, **Cancel** choice.*

5.3 Accessing the Menus

To access the menus:

1. Press and hold **F1** for approximately five seconds.
2. Release **F1** when the hourglass appears onscreen.

The screen below appears briefly.

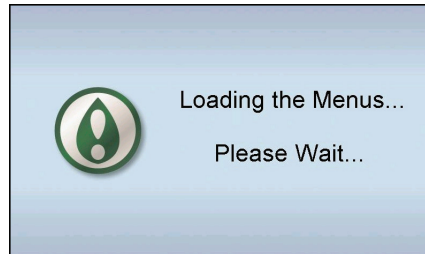

Figure 5.4 Menu Loading screen

The password entry screen shown in Figure 5.5 appears.



Figure 5.5 Password entry screen

3. Key in the password for the menu you want to access and press **Enter**.

Depending on the password you entered, one of the following screens appears.

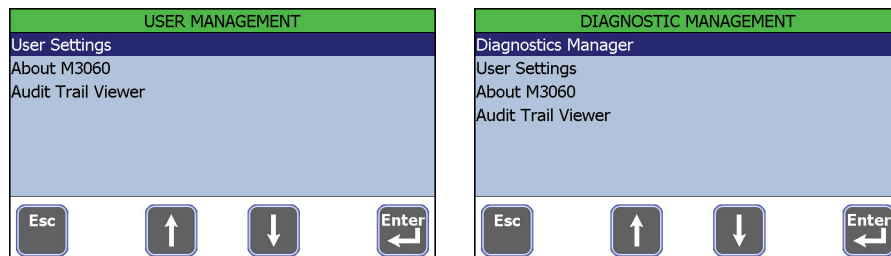

Figure 5.6 User Management (left) and Diagnostics Management (right)

5.4 User Settings Module

The **User Settings** module is available when you enter either of the passwords, however, this section assumes the individual is entering password 111.

When you access this module, you will see the screen shown in Figure 5.7.

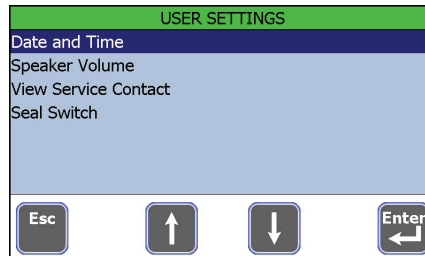

Figure 5.7 User Settings module

Each item in this module is explained in the following sections.

Press the **Esc** key in the **User Settings** screen to return to the **User Management** screen. Pick another module or press **Esc** to return to the default startup screen. If you press **Esc**, you will be asked if you want to save changes. Choose **Yes** to save changes and return to the main screen. Choose **No** to return to the main screen without saving the changes or press **Cancel** to return to the menu.

5.5 Set Date and Time

From the **User Settings** screen, select **Date and Time** and the display in Figure 5.8 appears.

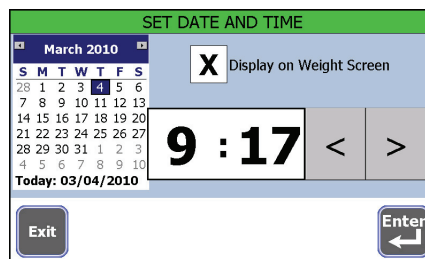

Figure 5.8 Date and Time entry screen



Use of sharp or metal objects will damage the touch screen. Use only your finger or plastic stylus.

5.5.1 To set the time

1. With the **Date And Time** entry screen showing, press the hour to highlight it.
2. Press the left arrow to decrease the value or the right arrow to increase the value.

- Repeat for minutes.



Time is always set as military time (24 hour) but displayed on the main screen as 12 or 24 hour clock time, depending on configuration.

- Press **Enter** to accept the time and return to the previous screen.

5.5.2 To set the date

- With the **Date And Time** entry screen showing, press on the month to display the drop down list of months.
 - Press on the current month.
- OR**
- Press the left or right arrows at the top of the calendar page to scroll month by month.

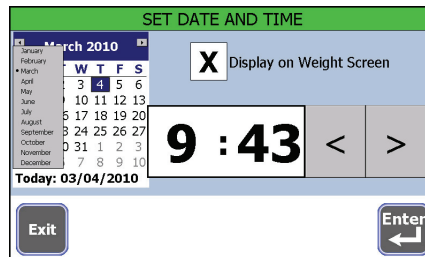

Figure 5.9 Month drop down list

- Press on the current day of the month.
- Press on the year and increase or decrease the value with the small arrows which appear, as necessary.



*If you have a USB keyboard attached, you can press on the year, type in the year and press the **Enter** key on your keyboard to accept the value.*

An **X** in the **Display on Weight Screen box** means the time and date will appear on the operator mode screen. Press the box to remove the **X** if you don't want time and date shown.

- Press **Enter** to accept the date and return to the previous screen.

5.6 Set Speaker Volume

1. From the **User Settings** screen, select **Speaker Volume** to set the speaker volume in the indicator.

A slider bar appears as shown in figure 5.10.

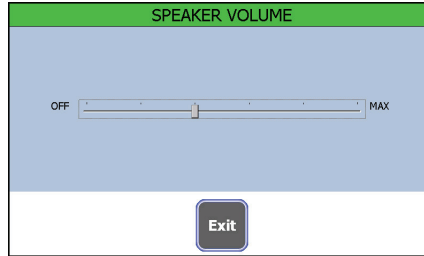

Figure 5.10 Speaker Volume

2. Press and drag the slider button to move it left or right to increase or decrease the volume.

A tone will sound with each step of the slider to indicate the sound level for that setting.

3. Press **Exit** to accept and return to the previous screen.

5.7 View Service Contact Information

From the **User Settings** screen, select **View Service Contact** to see contact information for your service provider. This information can be viewed but not changed.

Press **Exit** to return to the previous screen.

5.8 Seal Switch

This indicator has a Category 3 audit trail. For those states that require a physical seal, this item allows you to view the status of the seal switch; **SEALED** or **UNSEALED**. This information can be viewed but not changed.

Entering either password will allow you to view the status of the seal switch.

1. Select **Seal Switch** from the menu.

The indicator displays the current status of the seal switch.

2. Press **Exit** to return to the previous screen.

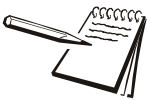

If using your scale for Legal-for-Trade applications (buying and / or selling based on weight), please check with your local weights and measures authority to learn what the requirements are.

For applications where you are not buying or selling based on weight, you may not need this information

5.9 About M3060 Module

The **About M3060** module shows you the revision and part number of the firmware. It is available when you enter either of the passwords.

1. Select the **About M3060** module and you will see a screen that shows you the Avery Weigh-Tronix company name, the model number, a copyright statement, the part number, the version of software in the instrument and revisions of related software.

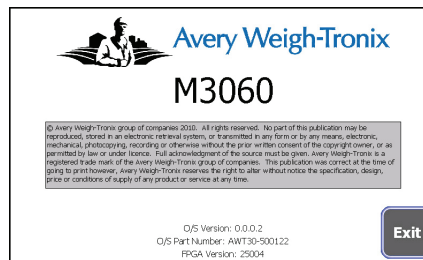

Figure 5.11 About M3060 screen

2. Press **Exit** to return to the previous screen.

5.10 Audit Trail Viewer Module

The **Audit Trail Viewer** module displays a list of dates and times when changes occurred. It is available when you enter either of the passwords.

1. Choose the **Audit Trail Viewer** and you will see a screen similar to the one below:

AUDIT TRAIL				
Record	Date	Parameter	Old Value	New Value
3	03/04/2010 11:30AM	Speaker Volume Updated		
2	03/02/2010 11:28AM	RESET TO DEFAULTS		
1	03/02/2010 11:28AM	AUDIT TRAIL CREATED		

Navigation buttons: Esc, Page Up, Print, Page Down, Enter

Figure 5.12 Sample Audit Trail

Figure 5.12 shows the record number, date and time, parameter and old and new values of changes that have been made to the indicator.

2. Press and drag the scroll bars or press the **Page UP** and **Page Down** keys to move left/right/up/down through the information.

3. Press the **Print** key to print the record to a connected peripheral device.

The file is printed as comma separated values with headers as shown below.

```
RecordID,Date,ParameterID,OldValue,NewValue
Record Number: 10,03/30/2010 05:02PM,Ethernet.Enable,Disabled,Enabled
Record Number: 9,03/30/2010 02:53PM,CONFIGURATION RESET,,
Record Number: 8,03/25/2010 10:16PM,ComPort.Power,Off,On
Record Number: 7,03/25/2010 10:09PM,Ethernet.Enable,Disabled,Enabled
Record Number: 6,03/25/2010 10:05PM,DateTime Updated,,
Record Number: 5,03/25/2010 09:58AM,DateTime Updated,,
Record Number: 4,03/24/2010 03:36PM,CALIBRATION RESET,,
Record Number: 3,03/24/2010 03:36PM,CONFIGURATION RESET,,
Record Number: 2,03/24/2010 03:36PM,RESET TO DEFAULTS,,
Record Number: 1,03/24/2010 03:36PM,AUDIT TRAIL CREATED,,
```

Figure 5.13 Sample Printed Audit Trail

5.11 Diagnostics Manager Module

The **DIAGNOSTICS MANAGER** module is only available when you enter password 911. For more information on how to access the menus, see [Accessing the Menus on page 33](#).

1. Key in password 911 and press **Enter**.

The following screen appears.

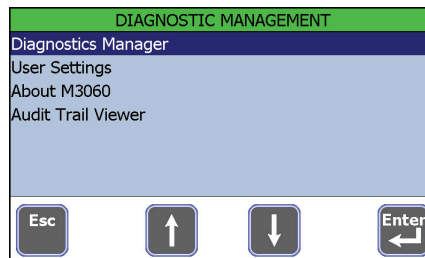

Figure 5.14 Diagnostic Management Screen

2. Select **DIAGNOSTICS MANAGER** and the screen below appears.

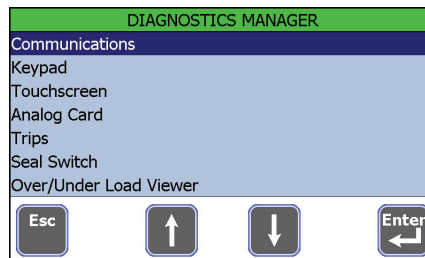

Figure 5.15 **DIAGNOSTICS MANAGER** screens

Each item is explained on the following pages.

5.12 Communications

When you select **Communications**, you will see the various communications options available. Select an item to view the status of the link.

5.12.1 Test Communications Ports

You can perform the following tests on any of the available communications (COM) ports.

Select **Com1 Diagnostics**, **Com2 Diagnostics** or **Com3 Diagnostics** from the menu to perform the LOOP/NO LOOP tests and check the RTS / CTS. See sample screen in Figure 5.16.

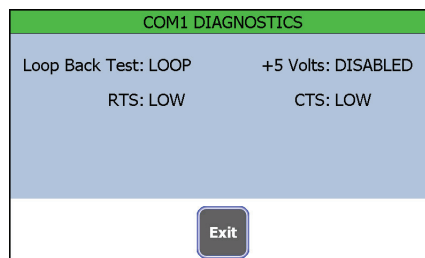
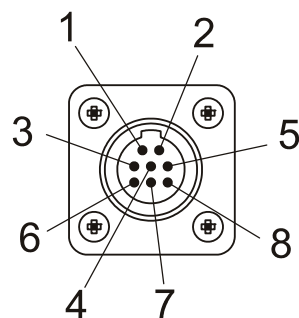

Figure 5.16 COMX Diagnostics Screen

Loop Back Test

Perform the Loop Back Test by placing a jumper between Pins 2 and 3 of the COM port being tested. When connected, the **NO LOOP** should change to **LOOP**. If this does not happen, contact your service representative.



COM Port

Pin	Description
1	N/C
2	XMT
3	N/C
4	RXD
5	GND
6	GND
7	+5 V
8	+8 V

Figure 5.17 Sample COM Port

+5 Volts

When a COM port is configured for a device that uses +5 volts, there should be 5 volts when measured between pins 5 and 9 of the connector with a multimeter. This test will show if the COM port's +5 volts is available (**GOOD**) or not available (**DISABLED**).

RTS, CTS

The RTS line is constantly changing from **HIGH** to **LOW** status. If you jumper pins 7 and 8 on the connector, the CTS line value should change from **HIGH** to **LOW**, matching the RTS. If this does not happen, contact your service representative.

Press **Exit** when you are finished with this screen and repeat for the other COM port, if necessary.

5.12.2 View Ethernet Settings

Depending on your application, your indicator may be configured to use ethernet communication.



If you are using the Standard Application, by default, your indicator is not set up to use ethernet. If you need this feature, please contact your local Avery Weigh-Tronix representative.

1. Select **Ethernet Diagnostics** from the **COMMUNICATIONS** screen to view ethernet settings and errors.

The **Ethernet Diagnostics** screen shows current network configuration on the left and current activity on the network such as: error messages for connection to a network, valid communications and successful and failed attempts to configure hardware on the right.

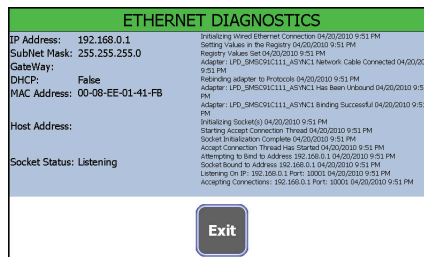

Figure 5.18 Ethernet Diagnostics Settings

This information can be viewed but not changed.

2. Press **Exit** when you are finished to return to the **COMMUNICATIONS** screen.
3. Press **Esc** to return to the **DIAGNOSTICS MANAGER** menu.

5.12.3 View WiFi Data

Depending on your application, your indicator may be configured to use wireless ethernet communication (WiFi).



If you are using the Standard Application, by default, your indicator is not set up to use WiFi. If you need this feature, please contact your local Avery Weigh-Tronix representative.

If your indicator is configured to use WiFi communication,

1. Select **WiFi Diagnostics** from the **COMMUNICATIONS** screen to view WiFi settings and errors.

The **WiFi** screen shows information for a Compact Flash WiFi card when it is installed. It shows current network configuration on the left and current activity on the network such as: error messages for connection to a network, valid communications and successful and failed attempts to configure hardware on the right.

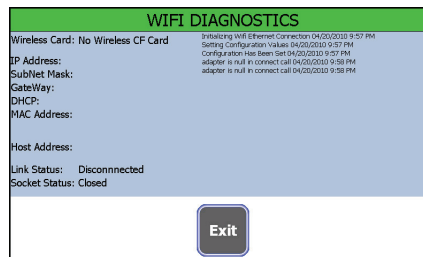

Figure 5.19 WiFi Diagnostics Settings (no WiFi installed)

This information can be viewed but not changed.

2. Press **Exit** when you are finished to return to the **COMMUNICATIONS** screen.
3. Press **Esc** to return to the **DIAGNOSTICS MANAGER** menu.

5.13 Test Keypad

1. To test the physical buttons (**On/Off**, **F1**, **F2**, **F3**, **Zero**), select **Keypad** from the **DIAGNOSTICS MANAGER** screen.

The following screen appears.

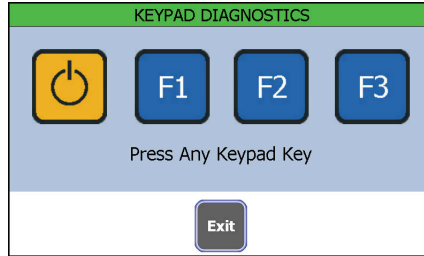

Figure 5.20 Keypad Diagnostics Screen 1

2. Press a key on the right side of the front panel. In the example, **F1** was pressed.

The corresponding key on the screen will turn green if the key is functioning correctly.

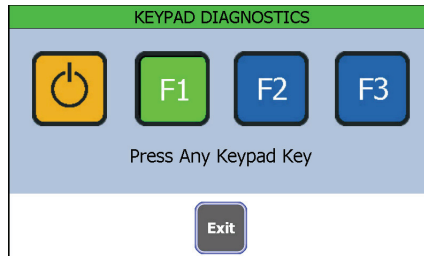

Figure 5.21 Keypad Diagnostics Screen 2

3. Press **Exit** to return to the previous screen.

5.14 Test Touchscreen

1. To test the touchscreen, select **Touchscreen** from the **DIAGNOSTICS MANAGER** screen.

The screen in Figure 5.22 appears.

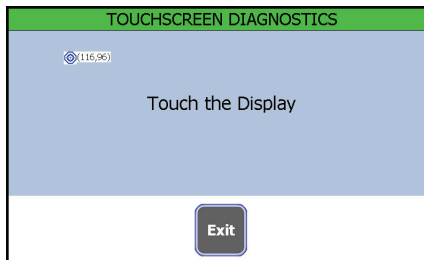

Figure 5.22 Touchscreen Diagnostics screen

2. Press any point on the display.

When the touchscreen is working properly, the small circular target will move to the spot you touched and show the screen coordinates.

3. Press **Exit** to return to the previous screen.

5.15 View Raw Counts

1. To view the raw counts, select **Scale** from the **DIAGNOSTICS MANAGER** screen.

The indicator shows the raw counts and the millivolts per volt rating for the scale.

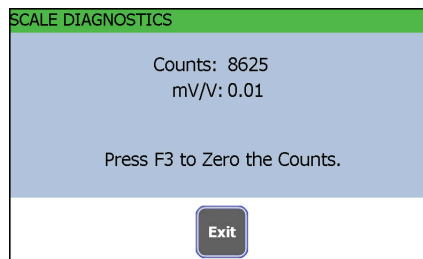

Figure 5.23 Raw Counts

2. Press **F3** to zero the counts, if necessary.
3. Press the **Exit** key when finished to return to the previous screen.

5.16 Trips

Select **Trips** from the **DIAGNOSTICS MANAGER** screen and the indicator shows the status (Active or Inactive) of the available inputs and outputs. Toggle the output on or off to change the status. Additional trips using and optional cable are available from your local Avery Weigh-Tronix representative.

5.17 Seal Switch

This indicator has a Category 3 audit trail. For those states that require a physical seal, this item allows you to view the status of the seal switch; **SEALED** or **UNSEALED**.



If using your scale for Legal-for-Trade applications (buying and / or selling based on weight), please check with your local weights and measures authority to learn what the requirements are.

For applications where you are not buying or selling based on weight, you may not need this information

1. Select **Seal Switch** from the menu.

The indicator displays the current status of the seal switch. This information can be viewed but not changed.

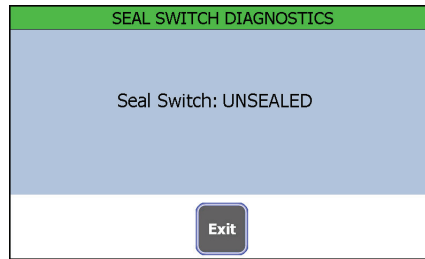

Figure 5.24 Seal Status

2. Press **Exit** to return to the previous screen.

5.18 Over/Under Load Viewer

Select **Over/Under Load Viewer** from the **DIAGNOSTICS MANAGER** screen and you will see a screen like this example:

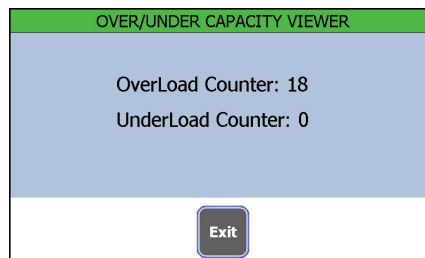

Figure 5.25 Overload / Underload counter

The default overload trigger is 105% of capacity. The default underload trigger is 20% of capacity.

5.19 Menu Maps

Refer to the following menu maps to help you through the available menus. Click on the blue text to jump to the section where that topic is covered. Additional password-protected menus are available in the service manual.

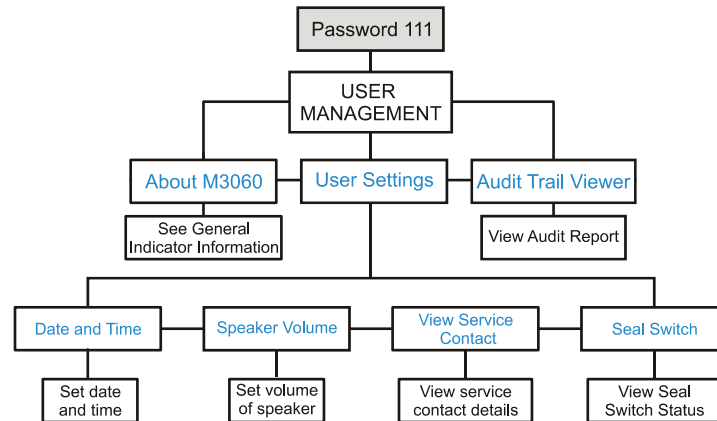

Figure 5.26 Menu Map Password 111

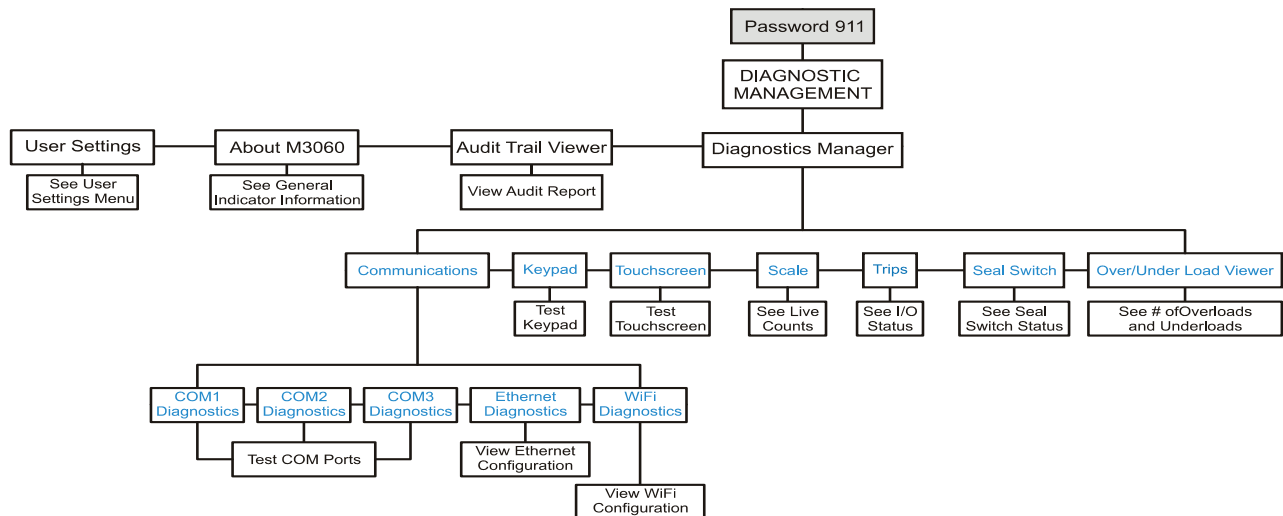

Figure 5.27 Menu Map Password 911

6 Extras

6.1 Configuration Codes

Refer to the following tables when entering in a custom configuration code. Find the specifications that match your system to find the correct code number.

Table 6.1 .Table for 1st, 2nd and 3rd CCN Digits

1st & 2nd Digits	CALIBRATION SIZE	CAPACITY x INCREMENT SIZE					
00	5/8 *	200 x 0.01	200 x 0.02	200 x 0.05	2K x 0.1	2K x 0.2	2K x 0.5
01	1	2K x 0.1	2K x 0.2	2K x 0.5	20K x 1	20K x 2	20K x 5
02	1-1/4	2K x 0.1	2K x 0.2	2K x 0.5	20K x 1	20K x 2	20K x 5
03	1-7/8	20K x 1	20K x 2	20K x 5	200K x 10	200K x 20	200K x 50
04	2	20K x 1	20K x 2	20K x 5	200K x 10	200K x 20	200K x 50
05	2-1/8	20K x 1	20K x 2	20K x 5	200K x 10	200K x 20	200K x 50
06	2-1/4	20K x 1	20K x 2	20K x 5	200K x 10	200K x 20	200K x 50
07	2-1/4D	20K x 1	20K x 2	20K x 5	200K x 10	200K x 20	200K x 50
08	2-1/4D-P	200K x 10	200K x 20	200K x 50	200K x 100	200K x 200	200K x 500
09	2-1/2	20K x 1	20K x 2	20K x 5	200K x 10	200K x 20	200K x 50
10	3-1/8	200K x 10	200K x 20	200K x 50	200K x 100	200K x 200	200K x 500
11	4	200K x 10	200K x 20	200K x 50	200K x 100	200K x 200	200K x 500
12	CC20/CC30	20K x1	20K x 2	20K x 5	200K x 10	200K x 20	200K x 50
13	Alley Weigh	2K x 0.1	2K x 0.2	2K x 0.5	20K x 1	20K x 2	20K x 5
14	CC30-3	20K x 1	20K x 2	20K x 5	200K x 10	200K x 20	200K x 50
15	Chute Weigh	20K x 1	20K x 2	20K x 5	200K x 10	200K x 20	200K x 50
16	CC-50	200K x 10	200K x 20	200K x 50	200K x 100	200K x 200	200K x 500
18	SPARE	20K x 1	20K x 2	20K x 5	200K x 10	200K x 20	200K x 50
20	1-digi	2K x 0.1	2K x 0.2	2K x 0.5	20K x 1	20K x 2	20K x 5
21	1 POLY(DIGI)	20K x 1	20K x 2	20K x 5	200K x 10	200K x 20	200K x50
22	1-7/8,2(DIGI)	20K x 1	20K x 2	20K x 5	200K x 10	200K x 20	200K x 50
23	2-1/8,2-1/2,2-7/8,3-3/4 (DIGI)	20K x 1	20K x 2	20K x 5	200K x 10	200K x 20	200K x 50
97	Custom Setting	200 x 0.01	200 x 0.02	200 x 0.05	2K x 0.1	2K x 0.2	2K x 0.5
98	Custom Setting	20K x 1	20K x 2	20K x 5	200K x 10	200K x 20	200K x 50
99	Custom Setting	200K x 100	200K x 200	200K x 500			
	3rd Digit	0	1	2	3	4	5

The fourth digit of the CCN is found in Table 6.2. For the standard application, choose any of the numbers found in the table. For custom applications, contact your Avery Weigh-Tronix representative for details.

Table 6.2 Table for 4th CCN Digit

4th Digit
0
1
2
3
4
5
6
7
8
9

The fifth digit of the CCN is found in Table 6.3.

Table 6.3 Table for 5th CCN Digit

5th Digit	units
0	Lb
1	Lb
2	Lb
3	Lb
4	Kg
5	Kg
6	Kg
7	Kg

Once you have your five digit configuration number, enter it as follows.

1. Press and hold the **F1** key until the screen changes.
2. Key in password 0603.
3. Press **Enter** two times.
4. Select **Configuration Number:**
5. Key in the five digit configuration number.
6. Press **Enter**.
7. Press **Esc** three times.
8. Press **Yes** when prompted to save.

6.2 Additional Hardware

The following items are available from your Avery Weigh-Tronix representative.

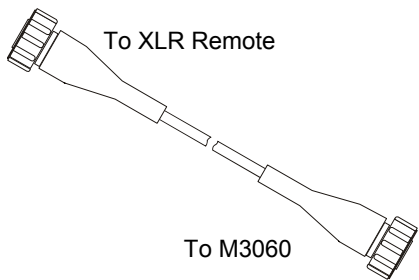
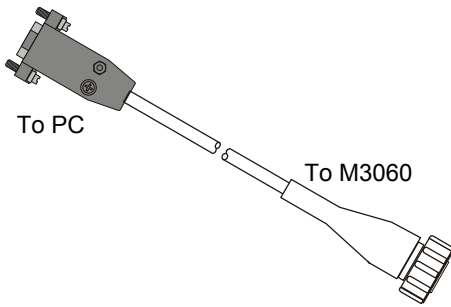

Part Number	Description	Use
53793-0018	Serial Cable; PC to M3060	Transfer data to and from PC
AWT25-500477	XLR Cable	Connect XLR-8 or XLR-12 Remote Display to M3060
AWT05-500696	RM 200	Communicate wirelessly with RD40RF Remote Display

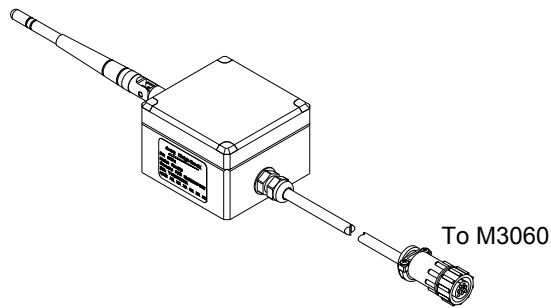

Standard Scale & Supply Company
25421 Glendale Avenue
Redford, MI 48239
313-255-6700
www.standardscale.com

