

# M3060 Indicator



## Service Manual

**© Avery Weigh-Tronix, LLC 2010. All rights reserved.**

No part of this publication may be reproduced, stored in an electronic retrieval system, or transmitted in any form or by any means, electronic, mechanical, photocopying, recording or otherwise without the prior written consent of the copyright owner, or as permitted by law or under license. Full acknowledgment of the source must be given. Avery Weigh-Tronix is a registered trade mark of the Avery Weigh-Tronix, LLC. This publication was correct at the time of going to print however, Avery Weigh-Tronix, LLC reserves the right to alter without notice the specification, design, price or conditions of supply of any product or service at any time.

All third party brands and product names used within this document are trademarks or registered trademarks of their respective holders.

# Table of Contents

|  | <i>page</i> |
|--|-------------|
| <b>Manual revision history</b> .....                     | 5           |
| <b>Chapter 1 General information and warnings</b> .....  | 7           |
| About this manual .....                                  | 7           |
| Text conventions .....                                   | 7           |
| Special messages .....                                   | 7           |
| Installation .....                                       | 8           |
| Safe handling of equipment with batteries .....          | 8           |
| Routine maintenance .....                                | 8           |
| Cleaning the machine .....                               | 9           |
| Training .....   | 9           |
| Sharp objects .....                                      | 9           |
| FCC and EMC declarations of compliance .....             | 9           |
| <b>Chapter 2 Introduction to the M3060</b> .....         | 10          |
| Front Panel and Keys .....                               | 10          |
| Display Symbols, Icons and Messages .....                | 11          |
| Rear Panel of the M3060 .....                            | 12          |
| Powering the M3060 .....                                 | 13          |
| Boot Errors .....  | 14          |
| Powering Off .....                                       | 15          |
| <b>Chapter 3 Overview of the Menus and Modules</b> ..... | 16          |
| Entering Alphanumeric Values .....                       | 17          |
| Accessing the Menus .....                                | 18          |
| Overview of the Modules .....                            | 19          |
| Overview of the <i>User Settings</i> Module .....        | 19          |
| Overview of the <i>About M3060</i> Module .....          | 19          |
| Overview of the <i>Audit Trail Viewer</i> Module .....   | 19          |
| Overview of the <i>Diagnostics Manager</i> Module .....  | 19          |
| Overview of the <i>Supervisor Settings</i> Module .....  | 20          |
| Overview of the <i>Setup Manager</i> Module .....        | 20          |
| <b>Chapter 4 User Settings Module</b> .....              | 22          |
| Date and Time .....                                      | 22          |
| Set the time .....                                       | 23          |
| Set the date .....                                       | 23          |
| Set Speaker Volume .....                                 | 24          |
| View Service Contact .....                               | 24          |
| View Seal Switch Status .....                            | 24          |
| <b>Chapter 5 About M3060 Module</b> .....                | 25          |
| <b>Chapter 6 Audit Trail Viewer Module</b> .....         | 26          |
| <b>Chapter 7 Diagnostics Manager Module</b> .....        | 27          |
| Communications .....                                     | 27          |
| Test Communications Ports .....                          | 27          |
| View Ethernet Settings .....                             | 29          |
| View WiFi Data .....                                     | 29          |
| Test Keypad .....  | 31          |
| Test Touchscreen .....                                   | 31          |
| View Raw Counts .....                                    | 32          |

|   |           |
|---|-----------|
| Test Trips .....  | 32        |
| View Seal Switch Status .....                           | 33        |
| View Over/Under Load Errors .....                       | 33        |
| <b>Chapter 8 Supervisor Settings Module .....</b>       | <b>34</b> |
| Set Gross Zero Band .....                               | 34        |
| Enter Identification Information .....                  | 35        |
| Calibrate TouchScreen .....                             | 35        |
| Enter Service Contact Information .....                 | 36        |
| <b>Chapter 9 Setup Manager Module .....</b>             | <b>37</b> |
| To Calibrate The M3060 .....                            | 38        |
| Setting the Zero Point .....                            | 39        |
| Setting Calibration Weight .....                        | 40        |
| Setting the Span .....                                  | 40        |
| Key In Configuration .....                              | 41        |
| Adjust Span .....                                       | 43        |
| View Live Weight .....                                  | 44        |
| Scale .....   | 44        |
| Configure Units .....                                   | 44        |
| Settings .....  | 46        |
| Set Filtering .....                                     | 46        |
| Set Motion/Zero .....                                   | 47        |
| Enable / Disable Auto Tare .....                        | 48        |
| Set Ranges .....  | 49        |
| Communications .....                                    | 50        |
| Communication Settings Glossary .....                   | 50        |
| Select Application .....                                | 53        |
| Miscellaneous .....                                     | 54        |
| Reset System .....                                      | 54        |
| Reset Passwords .....                                   | 55        |
| Set Display Properties .....                            | 55        |
| Set Time/Date Properties .....                          | 57        |
| <b>Chapter 10 Extras .....</b>                          | <b>58</b> |
| Installing the Compact Flash Cards .....                | 58        |
| Upgrading Firmware in the M3060 .....                   | 59        |
| Updating the M3060 Operating System .....               | 59        |
| SMA Protocol Table .....                                | 62        |
| <b>Chapter 11 Technical Illustrations .....</b>         | <b>65</b> |
| System Block Diagram .....                              | 65        |
| Exploded View of M3060 (Part number AWT15-500883) ..... | 66        |
| M3060 Indicator Parts List & Options .....              | 67        |
| Menu Maps .....   | 68        |
| Administration Management Menu .....                    | 69        |

# Manual revision history

| Current Issue | Date Created  | Details of Changes                           |
|---------------|---------------|--|
| AA            | June 2010     | New Manual                                   |
| AB            | December 2010 | Changed PN in parts list and added a fuse PN |
|               |               |  |
|               |               |  |
|               |               |  |



# 1 General information and warnings

## 1.1 About this manual

---

This manual is divided into chapters by the chapter number and the large text at the top of a page. Subsections are labeled as shown by the 1 and 1.1 headings shown above. The names of the chapter and the next subsection level appear at the top of alternating pages of the manual to remind you of where you are in the manual. The manual name and page numbers appear at the bottom of the pages.

### 1.1.1 Text conventions

---

Key names are shown in **bold** and reflect the case of the key being described. This applies to hard keys and onscreen or soft keys.

Displayed messages appear in ***bold italic*** type and reflect the case of the displayed message.

### 1.1.2 Special messages

---

Examples of special messages you will see in this manual are defined below. The signal words have specific meanings to alert you to additional information or the relative level of hazard.



---

***ELECTRICAL WARNING!***  
***THIS IS AN ELECTRICAL WARNING SYMBOL.***  
***ELECTRICAL WARNINGS MEAN THAT FAILURE TO FOLLOW SPECIFIC PRACTICES OR PROCEDURES MAY RESULT IN ELECTROCUTION, ARC BURNS, EXPLOSIONS OR OTHER HAZARDS THAT MAY CAUSE INJURY OR DEATH.***

---



---

***CAUTION!***  
***This is a Caution symbol.***  
***Cautions give information about procedures that, if not observed, could result in damage to equipment or corruption to and loss of data.***

---



---

***NOTE:*** *This is a Note symbol. Notes give additional and important information, hints and tips that help you to use your product.*

---

## 1.2 Installation

---



---

**DANGER: RISK OF ELECTRICAL SHOCK. NO USER SERVICEABLE PARTS. REFER TO QUALIFIED SERVICE PERSONNEL FOR SERVICE.**

---

### 1.2.1 Safe handling of equipment with batteries

---



---

**CAUTION: Danger of explosion if battery is incorrectly replaced. Replace only with the same or equivalent type recommended by the manufacturer. Dispose of used batteries according to the manufacturer's instructions.**

---

---

**ATTENTION: Il y a danger d'explosion s'il y a remplacement incorrect de la batterie, remplacer uniquement avec une batterie du même type ou d'un type équivalent recommandé par le constructeur. Mettre au rebut les batteries usagées conformément aux instructions du fabricant.**

---

## 1.3 Routine maintenance

---



---

**IMPORTANT: This equipment must be routinely checked for proper operation and calibration. Application and usage will determine the frequency of calibration required for safe operation.**

---

Always turn off the machine and isolate from the power supply before starting any routine maintenance to avoid the possibility of electric shock.

Make sure that it is placed securely on a flat and level surface.

## 1.4 Cleaning the machine

---

**Table 1.1 Cleaning DOs and DON'Ts**



| DO   | DO NOT  |
|--|---|
| Wipe down the outside of standard products with a clean cloth, moistened with water and a small amount of mild detergent | Attempt to clean the inside of the machine                                      |
|  | Use harsh abrasives, solvents, scouring cleaners or alkaline cleaning solutions |
| Spray the cloth when using a proprietary cleaning fluid  | Spray any liquid directly on to the display windows                             |

## 1.5 Training

---

Do not attempt to operate or complete any procedure on a machine unless you have received the appropriate training or read the instruction books.

To avoid the risk of RSI (Repetitive Strain Injury), place the machine on a surface which is ergonomically satisfactory to the user. Take frequent breaks during prolonged usage.

## 1.6 Sharp objects

---

Do not use sharp objects such as screwdrivers or long fingernails to operate the keys.

## 1.7 FCC and EMC declarations of compliance

---

### United States

This equipment has been tested and found to comply with the limits for a Class A digital device, pursuant to Part 15 of the FCC Rules. These limits are designed to provide reasonable protection against harmful interference when the equipment is operated in a commercial environment. This equipment generates, uses, and can radiate radio frequency energy and, if not installed and used in accordance with the instruction manual, may cause harmful interference to radio communications. Operation of this equipment in a residential area is likely to cause harmful interference in which case the user will be required to correct the interference at his own expense.

### European Countries

**WARNING:** This is a Class A product. In a domestic environment, this product may cause radio interference in which the user may be required to take adequate measures.

## 2 Introduction to the M3060

This manual covers service and calibration of the M3060 agricultural indicator.

This chapter introduces the components of the system and the following chapters cover the menus, communications settings, troubleshooting and technical illustrations.

### 2.1 Front Panel and Keys

The M3060, shown in Figure 2.1, has four keys on the front panel and a full color display with touch sensitive screen. The touch sensitive buttons on the bottom of the display work the same as traditional hard keys.



Figure 2.1 M3060 front panel

The chart below defines each of the keys shown in Figure 2.1

| Reference | Key    | Description   |
|-----------|--------|---|
| 1         | On/Off | Turn the indicator on and off.  |
| 2         | F1     | Press and hold the F1 key to access the password input screen. This is how you enter the menu system. This key is also used to toggle between upper case and lower case characters on the keys when alpha entry is allowed. For instructions on using the alphanumeric touchscreen, see <a href="#">Entering Alphanumeric Values on page 17</a> . |
| 3         | F2     | The function of this key varies, depending on your application.   |
| 4         | F3     | The function of this key varies, depending on your application.   |
| 5         | TARE   | Press TARE to tare the weight on the scale for net weighing.  |
| 6         | G/N    | Press G/N to toggle between gross and net weighing modes.   |
| 7         | HOLD   | Press HOLD to hold a displayed weight. The weight is retained in memory in case the indicator is turned off. When powered up again, the held weight will display. Press HOLD again to release the hold mode.  |
| 8         | PRINT  | Press PRINT to send data to an attached printer.  |
| 9         | ZERO   | Press ZERO to zero the gross weight.  |

## 2.2 Display Symbols, Icons and Messages

Figure 2.2 shows the standard application screen with all the annunciators illuminated. These items and other display messages are explained below.

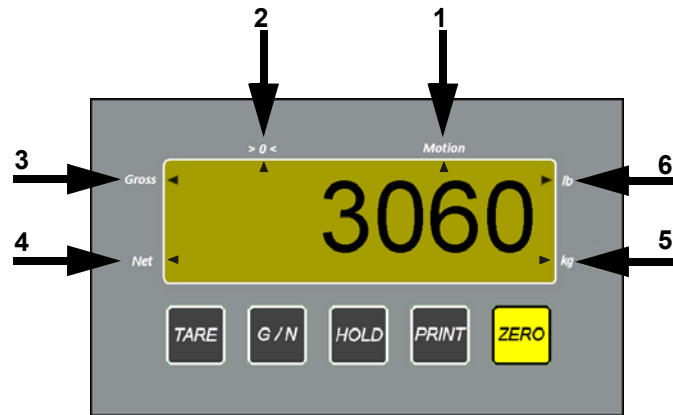

**Figure 2.2 Standard Application with all annunciators and touch keys**

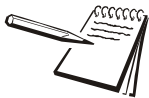

*The screen shown in Figure 2.2 is for illustration purposes only. You would not typically see ALL the annunciators at once.*

The standard annunciators are defined below.

| Reference | Description  |
|-----------|--|
| 1         | When the arrow points to this annunciator, the weight is unstable. This will disappear when the weight is stable. Transactions and scale functions will only operate when the scale is stable. |
| 2         | When the arrow points to this annunciator, the scale is at center of zero.   |
| 3         | When the arrow points to this annunciator, the indicator is in gross weighing mode.  |
| 4         | When the arrow points to this annunciator, the indicator is in net weighing mode.  |
| 5         | When the arrow points to this annunciator, the unit of measure is kilograms.   |
| 6         | When the arrow points to this annunciator, the unit of measure is pounds.  |

You may also see the following annunciators or onscreen messages in various other screens.

|                           |  |
|---------------------------|--|
| BUSY                      | At various times you will see popup boxes showing the system is busy. These will disappear after the process is complete.              |
| ~                         | This symbol may appear in some menu screens and is the same as the arrow pointing to <b>Motion</b> .                                   |
| UNDER LOAD                | Scale is below the configured underload range.   |
| -----                     | A series of five dashes at the bottom of the display indicates the scale is below the configured underload range (same as UNDER LOAD). |
| OVER LOAD                 | Scale is above the configured overload range.  |
| -----                     | A series of five dashes at the top of the display indicates the scale is above the configured overload range (same as OVER LOAD).      |
| NO ADC                    | No communication with the analog card.   |
| >0<                       | Scale is at center of zero. (Same as arrow pointing at >0<).   |
| lb/kg /gram/oz/<br>custom | The current unit of measure.   |
| Gross or Net              | Indicates current scale mode; Gross weighing or Net weighing. This is the same as the arrow pointing to <b>Gross</b> or <b>Net</b> .   |

### 2.3 Rear Panel of the M3060

The M3060 connectors are shown as they appear on the back of the indicator in Figure 2.3 and individually for greater detail following.

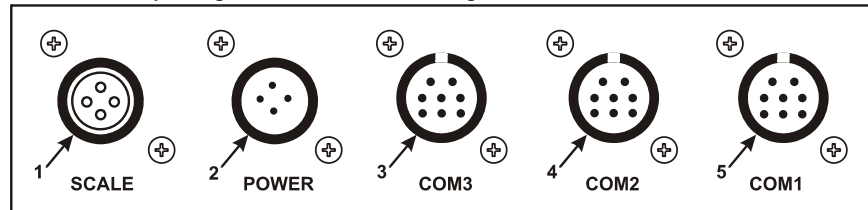

| Reference | Description     | Details   |
|-----------|-----------------|---|
| 1         | Scale Connector | Connect cable from junction box.  |
| 2         | Power Connector | Connect power cable.  |
| 3         | COM 3 Connector | Connect serial cable to peripheral. By default, this port is to connect to the XLR8 remote display. |
| 4         | COM 2 Connector | Connect serial cable to peripheral. By default, this port is to connect to the RD 40 RF.            |
| 5         | COM 1 Connector | Connect serial cable to peripheral. By default, this port is for a printer connection.              |

**Figure 2.3 M3060 connectors**

Each of the connectors shown in Figure 2.3 is explained in detail on the following pages.

## 2.4 Powering the M3060

---

To turn the indicator on, press and hold the **ON/OFF** key, shown below, until the red light above the key illuminates.



**Figure 2.4 On/Off Key**

The following screen appears



**Figure 2.5 Logo Screen shown during startup**





---

*Normal indicator functions will be available after the indicator completes startup.*

---

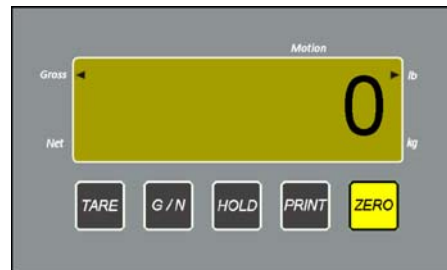
When the indicator finishes loading, a screen similar to [2.6](#) appears.



**Figure 2.6 Standard Application Screen**

## 2.5 Boot Errors

---

The following errors may appear during startup instead of the logo shown in [Figure 2.5](#).

### ADC Error

An **ADC Error** as shown in [Figure 2.7](#) indicates a problem with the analog to digital converter. It may be resolved by completely removing power (unplugging the unit) and then reapplying power by pressing and holding the power button for at least one second.

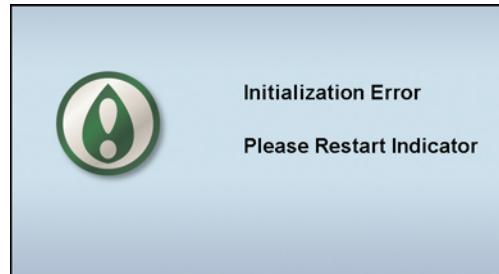

Figure 2.7 ADC Error

### FPGA Initialization Error

An **FPGA Initialization Error** as shown in [Figure 2.8](#) indicates a problem with the FPGA chip on the main board. Completely remove power (unplug the unit) and then reapply power to start the boot sequence again. If this does not clear the error, reload the operating system as explained in *Updating the M3060 Operating System* on [page 59](#). If the problem continues, replace the main board.

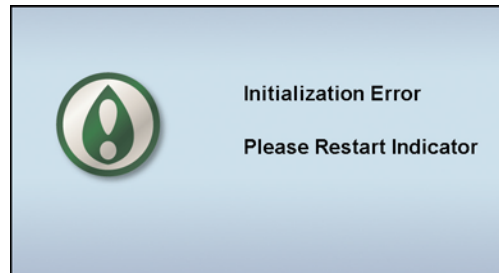

Figure 2.8 FPGA Initialization Error

### Application Not Found Error

If the screen in [Figure 2.9](#) appears, the operating system has become corrupted and needs to be reinstalled. See *Updating the M3060 Operating System* on [page 59](#).

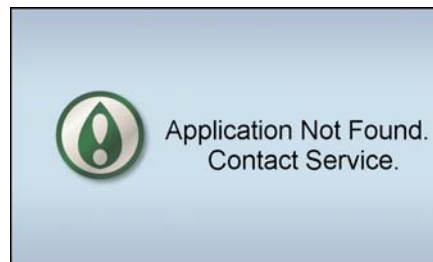

Figure 2.9 Application Not Found Error

## 2.6 Powering Off

---

If the indicator is configured with the standard application, follow these steps to shut down.

1. Press and hold the **ON/OFF** key.

The following screen appears.

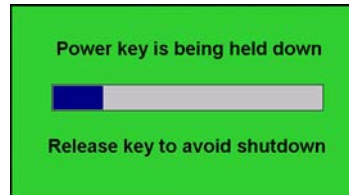

**Figure 2.10 Shutdown message 1**

2. Release the **ON/OFF** key when the screen prompts you to release it.

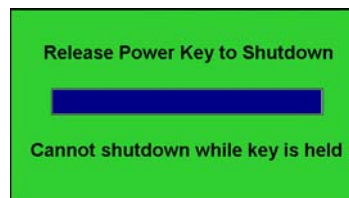
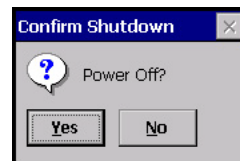

**Figure 2.11 Shutdown message 2**

If the indicator is not configured for the standard application, follow these steps to shut down.

1. Press the **ON/OFF** key.

The following screen appears.



2. Press **Yes** to confirm shutdown or **No** to abort shutdown.

### 3 Overview of the Menus and Modules

The M3060 indicator has four password protected menus. Each menu gives access to specific modules or areas of indicator function. Think of a module as a submenu or container for related items of scale configuration.

| MENU NAME                  | PASSWORD |
|----------------------------|----------|
| User Management Menu       | 111      |
| Diagnostic Management Menu | 911      |
| Supervisor Management Menu | 1793     |
| Admin. Management Menu     | 0603     |

Figure 3.1 shows a table explaining the module access granted by the different passwords. **A module remains the same no matter which menu you access it from, except for minor exceptions noted in the overview and full descriptions.**

Each successive menu shown in Figure 3.1 accesses more modules. This allows you to give passwords to personnel that will give them access only to those items they are cleared to change or view. See the complete menus in [section 11.4, Menu Maps](#).

|         |                     | Menus                          |                                      |                                      |  |
|---------|---------------------|--------------------------------|--------------------------------------|--------------------------------------|--|
|         |                     | Password 111                   | Password 911                         | Password 1793                        | Password 0603                            |
|         |                     | User Management Menu includes: | Diagnostic Management Menu includes: | Supervisor Management Menu includes: | Administration Management Menu includes: |
| Modules | Audit Trail         | ✓                              | ✓                                    | ✓                                    | ✓  |
|         | About M 3060        | ✓                              | ✓                                    | ✓                                    | ✓  |
|         | User Settings       | ✓                              | ✓                                    | ✓                                    | ✓  |
|         | Diagnostics Manager |                                | ✓                                    | ✓                                    | ✓  |
|         | Supervisor Settings |                                |                                      | ✓                                    | ✓  |
|         | Setup Manager       |                                |                                      |                                      | ✓  |

**Figure 3.1 Menus and the modules they contain**

This manual explains how to access the menus and modules but will explain the modules only once. Find the module you want to access in [Overview of the Modules on page 19](#), and full explanations in the associated chapter.

## 3.1 Entering Alphanumeric Values

The alphanumeric entry screen appears often during setup and use of the M3060. This screen mimics a cell phone pad for numeric or text entry. Follow these rules to enter an alpha, numeric or alphanumeric value:



**Figure 3.2 Alphanumeric entry screen (Password in this example)**

1. Once the entry screen appears, you have 10 seconds (default) to start entering characters before the screen reverts to the previous screen.
2. Touch a blue button to enter the number, decimal or + / - sign. The number you enter appears by the blinking cursor at the top left of the display.



*When you enter passwords, only asterisks ( \* ) appear in place of the entered characters. An optional, attached USB keyboard can help make accurate entries.*

3. The cursor automatically advances to the next position any time you wait for two seconds or more.
4. If you repeatedly touch the same key before the cursor advances, the display shows each successive number or character on the key. For example: Press the **6** key three times in rapid succession and the **N** appears on screen.
5. If you want to enter the same number repeatedly, you must hesitate two seconds between key presses or, you can speed up this process by pressing the **Adv** key between each numeric key to force the cursor to advance to the next position.
6. Press the **F1** key to switch the alpha characters on the keys to lower case letters. See Figure 3.3. Press the **F1** key again to return the display to upper case letters. This works only if the entry screen allows alpha character entry. Some screens allow only numeric entry.

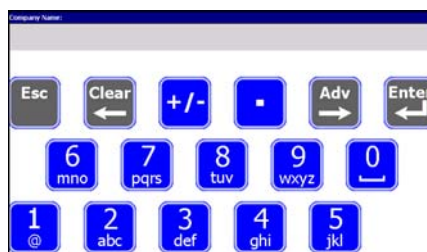

**Figure 3.3 Lower case letters**

7. Press the **Esc** key to exit and return to the previous screen. If you press the **Esc** key, the indicator will retain the previous value of the field that was being edited.
8. Press the **Clear** key to erase the last character entry or all highlighted characters.
9. Press the **Adv** key to advance the cursor to the next position.
10. When you are finished entering characters, press **Enter** to save the data.

## 3.2 Accessing the Menus

---

To access the menus:

1. Press and hold **F1** for approximately five seconds.
2. Release **F1** when the screen below appears.



**Figure 3.4 Menu Loading screen**

The password entry screen shown in Figure 3.3 appears



**Figure 3.5 Password entry screen**

3. Key in the password for the menu you want to access and press **Enter**.

## 3.3 Overview of the Modules

---

Each module is briefly explained in this section and fully explained in the chapters that follow.

### 3.3.1 Overview of the *User Settings* Module

---

The **User Settings** module appears in all four of the menus.

This module lets you view / change the following:

- **Date and Time** (set date and time)
- **Speaker Volume** (set the speaker volume)
- **View Service Contact** (view local service contact information)
- **Seal Switch** (view seal switch status)

For a full explanation of this module, see [chapter 4, User Settings Module](#).

### 3.3.2 Overview of the *About M3060* Module

---

The **About M3060** module appears in all four of the menus.

The screen that appears displays the part number and version of the software in the M3060.

For a full explanation of this module, see [About M3060 Module on page 25](#).

### 3.3.3 Overview of the *Audit Trail Viewer* Module

---

The **Audit Trail Viewer** module appears in all four of the menus and displays a list of items that have been changed on the indicator and the dates and times of the changes. This list cannot be changed or deleted but it can be printed as necessary.

For a full explanation of this module, see [chapter 6, Audit Trail Viewer Module](#).

### 3.3.4 Overview of the *Diagnostics Manager* Module

---

The **Diagnostics Manager** module appears in **Diagnostic**, **Supervisor** and **Administration Management** menus. It gives you access to the items listed below:

- **Communications**
  - Com1, 2 & 3 Diagnostics
  - Ethernet Diagnostics
  - WiFi Diagnostics
- **Keypad** Test keys.
- **Touchscreen** Test the touchscreen.
- **Scale** Test the A/D.
- **Trips** Test the status of each input and output.
- **Seal Switch** Shows status of the seal switch.

- **Over/Under Load Viewer** View number of overloads and underloads.

For a full explanation of this module, see [chapter 7, Diagnostics Manager Module](#).

### 3.3.5 Overview of the *Supervisor Settings* Module

---

The **Supervisor Settings** module appears in the **Supervisor** and **Administration Management** menus.

Use this module to set, perform or view the following:

- **Gross Zero Band**
  - Enter gross zero band in calibration units.
- **Identification**
  - Enter the Installation ID, Scale ID, Device Serial Number and Device Name.
- **Touchscreen Calibration**
  - Calibrate touchscreen accuracy
- **Service Contact Information**
  - Enter/view service contact information

For a full explanation of this module, see *Supervisor Settings Module on page 34*.

### 3.3.6 Overview of the *Setup Manager* Module

---

The **Setup Manager** module appears only in the **Administration Management** menu. This module contains the following:

- **Calibrate** (Calibrate the scale), which includes the following items:
  - Zero the scale
  - Set the span calibration weight
  - Perform span calibration
  - Enter scale configuration number
  - Adjust the span of the scale
  - View live weight from inside the menu
- **Scale** (Set the scale items), which includes the following items:
  - Set calibration unit of measure, scale unit of measure or custom unit
  - Set capacity and division size
  - Change configuration to meet NTEP requirements
  - Set filter parameters
  - Set Motion and Automatic Zero Tracking (AZT) parameters
  - Enable Auto Tare Clearing
  - Set the overload, underload, zero range, center of zero and autoprint parameters
- **Communications** (Set up communications), which includes the following items:
  - Com 1, 2 and 3
  - Ethernet

- WiFi
- **Application Selection** (Select the application)
  - Choose custom application, depending on configuration.
- **Miscellaneous** (Set miscellaneous other scale configuration items), which includes the following items:
  - Reset System
  - Passwords
  - Display
  - Time/Date

For a full explanation of this module, see [chapter 9, Setup Manager Module](#).



---

*Any time you exit a menu to return to normal operating mode, you are asked if you want to save any changes that have been made. You can choose **Yes**, **No**, or **Cancel**. Choose **Yes** to save changes and return to normal operation. Choose **No** to disregard any changes made while in the menu and return to normal operation. Press **Cancel** to stay in the menu.*

*The one exception to this is the Time and Date window. When you accept a new setting for time and date, that change takes place immediately and is unaffected by the **Yes**, **No**, **Cancel** choice.*

---

## 4 User Settings Module

The **User Settings** module is available when you enter any of the passwords, however, this section assumes the individual is entering password 111. For more information on how to access the menus, see [Accessing the Menus on page 18](#).

When you access this module, you will see the screen shown in Figure 4.1.



Figure 4.1 Choices in **User Settings** module

Each item in this module is explained below.

Press the **Esc** key in the **User Settings** screen to return to the **User Management** screen. Pick another module or press **Esc** to return to the default startup screen. If you press **ESC**, you will be asked if you want to save changes. Choose **Yes** to save changes and return to the main screen, choose **No** to return to the main screen without saving the changes or press **Cancel** to return to the menu.

### 4.1 Date and Time

---

From the **User Settings** screen, select **Date and Time** and the display in Figure 4.2 appears.

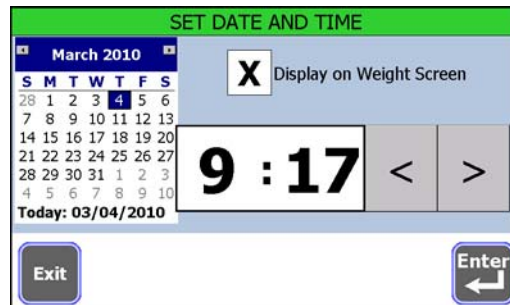

Figure 4.2 Date and Time entry screen



---

**Use of sharp or metal objects will damage the touch screen. Use only your finger or plastic stylus.**

---

### 4.1.1 Set the time

1. With the **Date and Time** entry screen showing, press the hour to highlight it.
2. Click the left arrow to decrease the value or the right arrow to increase the value.
3. Repeat for minutes.



---

*Time is always set as military time (24 hour) but displayed on the main screen as 12 or 24 hour clock time, depending on configuration.*

---

4. Press **Enter** to accept the time and return to the previous screen.

### 4.1.2 Set the date

1. With the **Date and Time** entry screen showing, click on the month to display the drop down list of months.
2. Click on the current month.

**OR**

2. Click the left or right arrows at the top of the calendar page to scroll month by month.

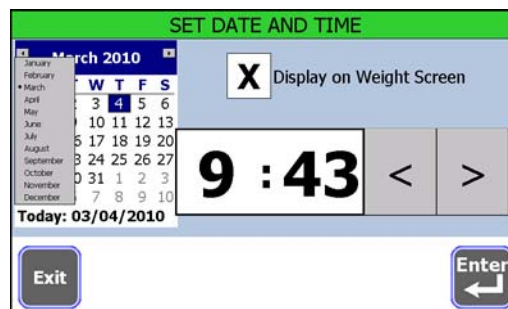

**Figure 4.3 Month drop down list**

3. Click on the current day of the month.
4. Click on the year and increase or decrease the value with the small arrows which appear, as necessary.



---

*If you have a USB keyboard attached, you can click on the year, type in the year and press the **Enter** key on your keyboard to accept the value.*

---

An **X** in the **Display on Weight Screen** box means the time and date will appear on the operator mode screen. Press the box to remove the **X** if you don't want time and date shown.

5. Press **Enter** to accept the date and return to the previous screen.

## 4.2 Set Speaker Volume

---

1. From the **User Settings** screen, select **Speaker Volume** to set the speaker volume in the indicator.

A slider bar appears. See Figure 4.4.

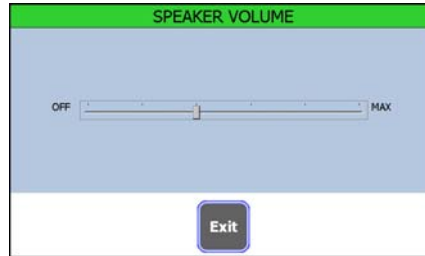

**Figure 4.4 Speaker Volume**

2. Click and drag the slider button to move it left or right to increase or decrease the volume.

A tone will sound with each step of the slider to indicate the sound level for that setting.

3. Click **Exit** to accept and return to the previous screen.

## 4.3 View Service Contact

---

From the **User Settings** screen, select **View Service Contact** to see contact information for your service provider. This information can be viewed but not changed from this module. See *Enter Service Contact Information* on [page 36](#) for instructions on inputting this information.

Press **Exit** to return to the main menu.

## 4.4 View Seal Switch Status

---

This indicator has a Category 3 audit trail. For states that require a physical seal, this item allows you to view the status of the seal switch; **SEALED** or **UNSEALED**.

Entering any password will allow you to view the status of the seal switch.

1. Select **Seal Switch** from the menu.

The indicator displays the current status of the seal switch.

2. Press **Exit** to return to the previous screen.

The physical jumper (switch) is found at P20 on the main board. If the jumper is on the pins, the indicator is sealed. If sealed, the **Administration Management** menu cannot be accessed.

The back of the indicator must be removed to change the physical seal state. See [page 66](#) for exploded views of the indicator for disassembly purposes.

## 5 About M3060 Module

The **About M3060** module shows you the revision and part number of the firmware. It is available when you enter any of the passwords.

1. Select the **About M3060** module and you will see a screen that shows you the Avery Weigh-Tronix company name, the model number, a copyright statement, the part number, the version of software in the instrument and revisions of related software.



**Figure 5.1 About M3060 screen**

2. Press **Exit** to return to the previous screen.

## 6 Audit Trail Viewer Module

The **Audit Trail Viewer** module displays a list of dates and times when changes occurred. It is available when you enter any of the passwords.

1. Choose the **Audit Trail Viewer** and you will see a screen similar to the one below:

| Record | Date               | Parameter              | Old Value | New Value |
|--------|--------------------|------------------------|-----------|-----------|
| 3      | 03/04/2010 11:30AM | Speaker Volume Updated |           |           |
| 2      | 03/02/2010 11:28AM | RESET TO DEFAULTS      |           |           |
| 1      | 03/02/2010 11:28AM | AUDIT TRAIL CREATED    |           |           |

**Figure 6.1 Sample Audit Trail**

Figure 6.1 shows the record number, date and time, parameter and old and new values of changes that have been made to the indicator.

2. Press and drag the scroll bars or press the **Page UP** and **Page DOWN** keys to move left/right/up/down through the information.
3. Press the **Print** key to print the audit trail record to a connected peripheral device.
4. Select the COM port to print to when prompted.



---

*The serial port you are using to print this information must be set up for PRINT EVENT mode before the audit trail will print.*

---

The indicator sends the audit trail to the connected device as comma separated values with headers as shown below and returns to the **AUDIT TRAIL** screen.

```
RecordID,Date,ParameterID,OldValue,NewValue
Record Number: 10,03/30/2010 05:02PM,Ethernet.Enable,Disabled,Enabled
Record Number: 9,03/30/2010 02:53PM,CONFIGURATION RESET,,
Record Number: 8,03/25/2010 10:16PM,ComPort.Power,Off,On
Record Number: 7,03/25/2010 10:09PM,Ethernet.Enable,Disabled,Enabled
Record Number: 6,03/25/2010 10:05PM,DateTime Updated,,
Record Number: 5,03/25/2010 09:58AM,DateTime Updated,,
Record Number: 4,03/24/2010 03:36PM,CALIBRATION RESET,,
Record Number: 3,03/24/2010 03:36PM,CONFIGURATION RESET,,
Record Number: 2,03/24/2010 03:36PM,RESET TO DEFAULTS,,
Record Number: 1,03/24/2010 03:36PM,AUDIT TRAIL CREATED,,
```

**Figure 6.2 Sample Audit Trail Printout**

5. Press **Enter** or **Esc** to return to the previous screen.

## 7 Diagnostics Manager Module

The **DIAGNOSTICS MANAGER** module is available when you access the **Diagnostics Management** menu, the **Supervisor Management** menu or the **Admin Management** menu, however this section assumes the individual is entering password 911. For more information on how to access the menus, see *Overview of the Menus and Modules* on page 16.

Select the **DIAGNOSTICS MANAGER** module and you will see the screen shown in Figure 7.1.

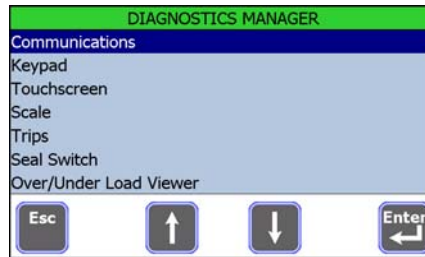

Figure 7.1 Diagnostics Manager screens

Each item is explained on the following pages.

### 7.1 Communications

---

When you select **Communications**, you will see the various communications options available. Select an item to view the status of the link.

#### 7.1.1 Test Communications Ports

---

You can perform the following tests on any of the available communications (COM) ports.

Select **Com1 Diagnostics**, **Com2 Diagnostics** or **Com3 Diagnostics** from the menu to perform the LOOP/NO LOOP tests and check the RTS / CTS. See sample screen in Figure 7.2.

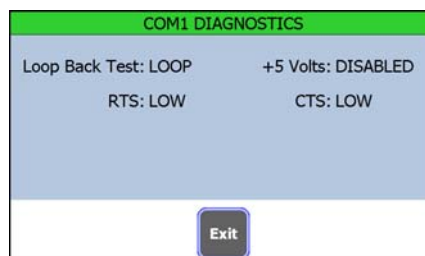
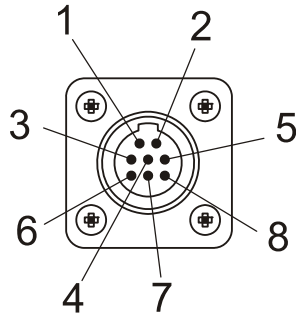

Figure 7.2 COMX Diagnostics Screen

### Loop Back Test

Perform the Loop Back Test by placing a jumper between Pins 2 and 4 of the COM port being tested. When connected, the **NO LOOP** should change to **LOOP**.



| COM Port |             |
|----------|-------------|
| Pin      | Description |
| 1        | N/C         |
| 2        | XMT         |
| 3        | N/C         |
| 4        | RXD         |
| 5        | GND         |
| 6        | GND         |
| 7        | +5 V        |
| 8        | +8 V        |

Figure 7.3 Sample COM Port

### +5 Volts

When a COM port is configured for a device that uses +5 volts, there should be 5 volts when measured between pins 5 and 9 of the connector with a multimeter. This test will show if the COM port's +5 volts is available (**GOOD**) or not available (**DISABLED**).

### RTS, CTS

The RTS line is constantly changing from **HIGH** to **LOW** status. If you jumper pins 7 and 8 on the connector, the CTS line value should change from **HIGH** to **LOW**, matching the RTS.

Press **Exit** when you are finished with this screen and repeat for the next COM port, if necessary.

## 7.1.2 View Ethernet Settings

Depending on the application installed in the indicator, the M3060 may be configured to use ethernet communication.



For the Standard Application, by default, the indicator is not set up to use ethernet. For information on how to set up the indicator for ethernet, see [Communications on page 50](#).

1. Select **Ethernet Diagnostics** from the **COMMUNICATIONS** screen to view ethernet settings and errors.

The **Ethernet Diagnostics** screen shows current network configuration on the left and current activity on the network such as: error messages for connection to a network, valid communications and successful and failed attempts to configure hardware on the right.



Figure 7.4 Ethernet Diagnostics Settings

This information can be viewed but not changed.

2. Press **Exit** when you are finished to return to the **COMMUNICATIONS** screen.
3. Press **Esc** to return to the **DIAGNOSTICS MANAGER** menu.

## 7.1.3 View WiFi Data

Depending on the application, the M3060 indicator may be configured to use wireless ethernet communication (WiFi).



By default, the M3060 is not set up to use WiFi. For information on how to set up the indicator for ethernet, see [Communications on page 50](#).

1. Select **WiFi Diagnostics** from the **COMMUNICATIONS** screen to view WiFi settings and errors.

The **WiFi** screen shows information for a Compact Flash WiFi card when it is installed. It shows current network configuration on the left and current activity on the network such as: error messages for connection to a network, valid communications and successful and failed attempts to configure hardware on the right.



**Figure 7.5 WiFi Diagnostics Settings (no WiFi installed)**

This information can be viewed but not changed.

2. Press **Exit** when you are finished to return to the **COMMUNICATIONS** screen.
3. Press **Esc** to return to the **DIAGNOSTICS MANAGER** menu.

Press **Exit** when you are finished with either screen to return to the **COMMUNICATIONS** screen.

Press **Esc** to return to the **DIAGNOSTICS MANAGER** menu.

## 7.2 Test Keypad

---

To test the physical buttons (**On/Off**, **F1**, **F2**, **F3**), select **Keypad** from the **DIAGNOSTICS MANAGER** screen to test the keypad.

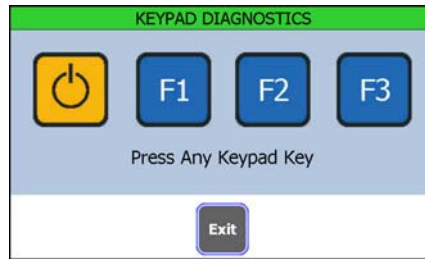

**Figure 7.6 Keypad Diagnostics Screen 1**

1. Press a key on the right side of the front panel. In the example, **F1** was pressed  
The corresponding key on the screen will turn green if the key is functioning correctly.

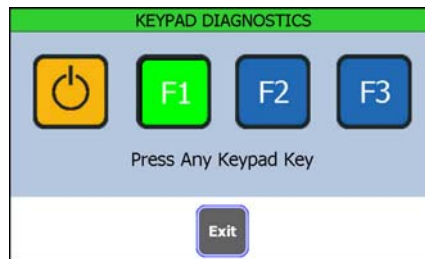

**Figure 7.7 Keypad Diagnostics Screen 2**

2. Press **Exit** to return to the previous screen.

## 7.3 Test Touchscreen

---

1. To test the touchscreen, select **Touchscreen** from the **DIAGNOSTICS MANAGER** screen.

The screen in Figure 7.8 appears.



**Figure 7.8 Touchscreen Diagnostics screen**

2. Press any point on the display.

When the touchscreen is working properly, the small circular target will move to the spot you touched and show the screen coordinates.

3. Press **Exit** to return to the menu.

## 7.4 View Raw Counts

---

1. To view the raw counts, select **Scale** from the **DIAGNOSTICS MANAGER** screen.

The indicator shows the raw counts and the millivolts per volt rating for the scale.

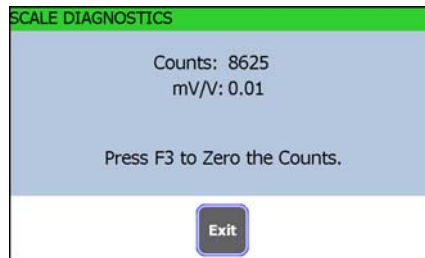

**Figure 7.9 Raw Counts**

2. Press **F3** to zero the counts, if necessary.
3. Press the **Exit** key when finished to return to the previous screen.

## 7.5 Test Trips

---

Select **Trips** from the **DIAGNOSTICS MANAGER** screen and the indicator shows the status (Active or Inactive) of the available inputs and outputs. Toggle the output on or off to change the status.

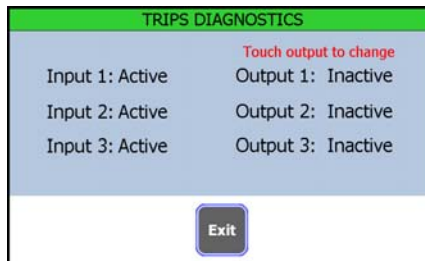

**Figure 7.10 Trips Diagnostics Screen**

## 7.6 View Seal Switch Status

---

This indicator has a Category 3 audit trail. For those states that require a physical seal in order to comply with Legal-for-Trade requirements, this item allows you to view the status of the seal switch; **SEALED** or **UNSEALED**.



---

*For Legal-for-Trade applications, please check with the local weights and measures authority to learn what the requirements are.*

---

Entering any password will allow you to view the status of the seal switch, however the **Administration Management** menu cannot be accessed if the indicator is sealed.

1. Select **Seal Switch** from the menu.

The indicator displays the current status of the seal switch.



**Figure 7.11 Seal Status**

2. Press **Exit** to return to the previous screen.

If the indicator is sealed, you must remove the back of the indicator and move the jumper located at P20 on the main board. Refer to [chapter 11, Technical Illustrations](#) for more information.

## 7.7 View Over/Under Load Errors

---

Select **Over/Under Load Viewer** from the **DIAGNOSTICS MANAGER** screen and you will see a screen like this example:

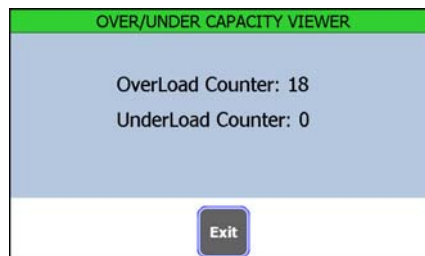

**Figure 7.12 Overload / Underload counter**

Default overload trigger is set to 105% of capacity. Default underload trigger is set to 20% of capacity. For information on changing these values, see [Settings on page 46](#).

## 8 Supervisor Settings Module

The **Supervisor Settings** module is available when you access the **Supervisor Management** menu or the **Admin Management** menu however, this section assumes the individual is entering password 1793. For more information on how to access the menus, see *Overview of the Menus and Modules* on page 16.

Select the **Supervisor Settings** module and you will see a screen similar to the one in Figure 8.1.

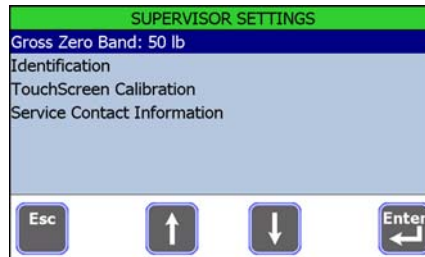

Figure 8.1 Supervisor Settings screen

Each item is explained on the following pages.

### 8.1 Set Gross Zero Band

---

Gross zero band is used for these operations:

- The weight needs to fall below the gross zero band value before storing the next transaction.
  - If Auto Tare Clear is enabled, when a weight which had been above the gross zero band falls below the gross zero band weight value, the active tare is cleared.
  - Verify return to zero was complete.
1. Select **Gross Zero Band** from the **Supervisor Settings** module.

The alphanumeric entry screen appears with the current value.



Figure 8.2 Gross Zero Band Entry Screen with Default Setting

2. Key in a gross zero band value, in calibration units as necessary.
3. Press **Enter** to accept it.

## 8.2 Enter Identification Information

---

Select **Identification** from the **Supervisor Settings** module and the screen shown in Figure 8.3 appears.



**Figure 8.3 Identification screen**

Use these items to enter identification information for the system.

**Installation ID:** Select **Installation ID** to enter a site ID. When you select this item, the alphanumeric entry screen appears. Enter the installation ID and press **Enter** to accept the information and return to this menu.

**Scale ID:** Select **Scale ID** to enter a scale ID. When you select this item, the alphanumeric entry screen appears. Enter your ID and press **Enter** to accept the information and return to this menu.

**Device Serial Number:** Select **Device Serial Number** to enter a device serial number. When you select this item the alphanumeric entry screen appears. Enter your serial number and press **Enter** to accept the information and return to this menu.

**Device Name:** Select **Device Name** to enter a device name, such as M3060. When you select this item the alphanumeric entry screen appears. Enter the name and press **Enter** to accept the information and return to this menu.

## 8.3 Calibrate TouchScreen

---

Select **TouchScreen Calibration** from the **Supervisor Settings** module to calibrate the touchscreen for accuracy. Follow the onscreen instructions shown below:

**Carefully press and briefly hold stylus on the center of the target. Repeat as the target moves around the screen.**

Depending on whether you have a USB keyboard attached to the indicator, the screen will inform you how to proceed to finish the test or exit the screen.

## 8.4 Enter Service Contact Information

---

Choose **Service Contact Information** from the **Supervisor Settings** module to enter contact information for your service provider. The screen in Figure 8.4 appears.

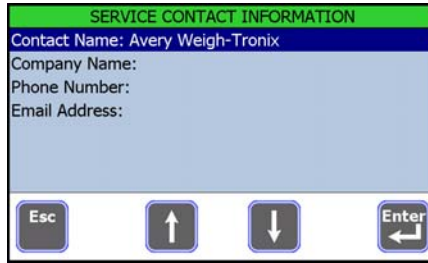

**Figure 8.4** Service Contact screen

1. Select an item from the list.  
The alphanumeric entry screen appears.
2. Enter the appropriate information
3. Press **Enter** to accept the information and return to this screen.
4. Complete as many fields as you like. When finished, press the **Esc** key to return to the **Supervisor Settings** screen.

## 9 Setup Manager Module

The **Setup Manager** module is only available when you access the **Admin Management** menu (password 0603). For more information on how to access the menus, see *Overview of the Menus and Modules* [on page 16](#).

When you access the **Setup Manager** module, you will see the screen in [Figure 9.1](#).

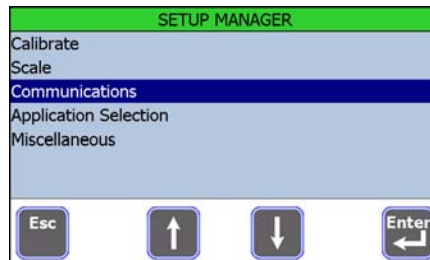

**Figure 9.1** Setup Manager screen

This module contains the following items:

### **Calibrate**

Select **Calibrate** to set Zero, set Calibration Weight, set Span, enter the Configuration Number, adjust the Span (number of divisions) and View Live Weight reading. See *To Calibrate The M3060* [on page 38](#) for complete information.

### **Scale**

Select **Scale** to set the various components of: Units, Settings, Filter, Motion/Zero, Tare, and Ranges. See *Scale* [on page 44](#) for complete information.

### **Communications**

Select **Communications** to access setup for the COM ports, Ethernet and WiFi connections. See *Communications* [on page 50](#) for complete information.

### **Application Selection**

Select **Application Mode** to choose an application for the M3060. See *Select Application* [on page 53](#).

### **Miscellaneous**

Select **Miscellaneous** to do the following:

- Reset system parameters
- Change passwords
- Change display properties
- Set time and date formats

See *Miscellaneous* [on page 54](#) for complete information.

## 9.1 To Calibrate The M3060

---

The M3060 is an analog system. This section covers the calibration process for the scale system.

Select the **Calibrate** item from the **Setup Manager** module and the screen shown in Figure 9.2 appears.

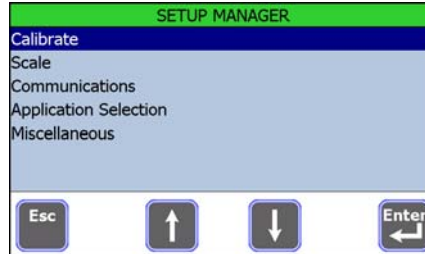

**Figure 9.2 Calibrate screen**

A brief summary of each item in this screen follows:

- **Zero** Set the zero point for the scale. For full details, see [Setting the Zero Point on page 39](#).
- **Cal Weight:** This is the calibration (span) weight value you will use when you perform the span. Select **Cal Weight**, key in the value of the weight you are using and press the **Enter** key.
- **Span** Select **Span** to set the span. For full details see [Setting the Span on page 40](#).
- **Configuration Number** Select **Configuration Number** to perform a key in calibration. For full details, see [Key In Configuration on page 41](#).
- **Span Adjust** Adjust the span up or down one division. For full details, see [Adjust Span on page 43](#).
- **View Live Weight** Select **View Live Weight** to view a live weight reading without exiting the menus.



---

The screen is touch sensitive. When instructions say to **highlight** an item, use the arrow keys to move the highlight bar to that item. When instructions say to **select** an item, use the up or down arrow to move the blue highlight bar to that item and press the **Enter** key or simply touch the selection on screen.

---

### 9.1.1 Setting the Zero Point

Place any deadload on the scale.

1. Access the **CALIBRATE** screen and select **Zero** to begin the zeroing process.

The following is displayed:

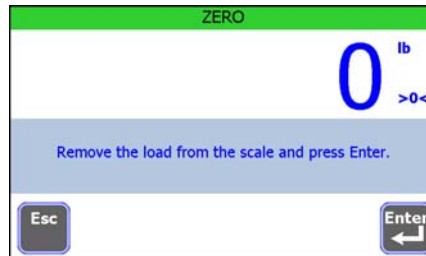

2. Remove all weight from the scale, except deadload, and press **Enter**.

The following is briefly displayed:



Followed by:

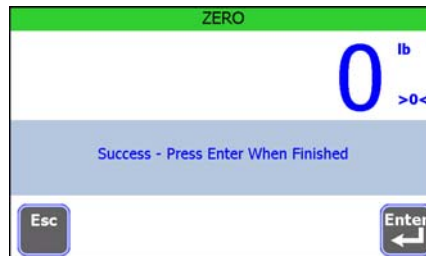

3. Press the **Enter** key to return to the **CALIBRATE** screen.

If you are done with calibration, press the **Esc** key repeatedly until you are prompted to save the changes you've made. Press the **Yes** key to save, press the **No** key to exit without saving and press the **Cancel** key to remain in the **Administration Management** screen.

### 9.1.2 Setting Calibration Weight



---

The default calibration weight (span weight) is 5000 lbs.

---

1. To change the calibration weight of the scale, access the **CALIBRATE** screen and select **Cal Weight**.
2. Key in the new calibration weight using the keypad and press **Enter**.

The indicator returns to the **CALIBATE** screen and you can continue with calibration procedures.

### 9.1.3 Setting the Span

Once you have established a zero point for the indicator, you will use the weight selected in this section to establish an accurate span of the scale.

1. Access the **CALIBRATE** screen and select **Span** to begin the spanning process.

The following is displayed:

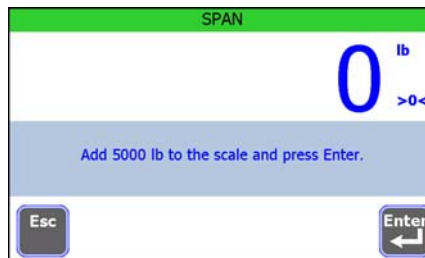

2. Follow the prompt and place test weight (the weight you entered) on the scale and press the **Enter** key.

The following is briefly displayed:



followed by a message saying whether span was successful or not. Repeat span process if unsuccessful.

3. Press **Enter** to return to the **CALIBRATE** screen.

If you are done with calibration, press the **Esc** key repeatedly until you are prompted to save the changes you've made. Press the **Yes** key to save, press the **No** key to exit without saving and press the **Cancel** key to remain in the **Administration Management** screen.



---

*The M3060 is factory calibrated. If zero and span functions are required or if you cannot successfully complete the zero and span functions, reinspect the customer's equipment for damage.*

---

#### 9.1.4 Key In Configuration

The Model 3060 indicator is pre-calibrated at Avery Weigh-Tronix with the appropriate code number specified by the OEM, or leaves with a factory calibration number of 18030. This section shows you how to find and enter a configuration number that sets up the indicator for the type of Weigh Bar, capacity, increment, print format, units, and auto-loc.



---

*Your system may not have all of the features shown in the examples.*

---

#### **Example:**

**20,000 x 5 lb, 2 1/8 calibration, print format 3, therefore code= 05133.**

1. From the **CALIBRATE** menu, select **Configuration Number**.  
The alphanumeric keypad displays.
2. Key in the configuration number. Refer to the following tables for appropriate values.
3. Press **Enter**.



---

*Configuration numbers are five digits long. You cannot enter more than five. If you enter fewer than five digits, the indicator prompts you to enter a correct code.*

---

The indicator returns to the **CALIBRATE** menu.

#### **Configuration Codes**

The following tables show how to establish a configuration number to configure the M3060 indicator.

| 1st & 2nd Digits | CALIBRATION SIZE               | CAPACITY x INCREMENT SIZE |            |            |            |            |            |
|------------------|--------------------------------|---------------------------|------------|------------|------------|------------|------------|
|                  |                                |                           |            |            |            |            |            |
| 00               | 5/8 *                          | 200 x 0.01                | 200 x 0.02 | 200 x 0.05 | 2K x 0.1   | 2K x 0.2   | 2K x 0.5   |
| 01               | 1                              | 2K x 0.1                  | 2K x 0.2   | 2K x 0.5   | 20K x 1    | 20K x 2    | 20K x 5    |
| 02               | 1-1/4                          | 2K x 0.1                  | 2K x 0.2   | 2K x 0.5   | 20K x 1    | 20K x 2    | 20K x 5    |
| 03               | 1-7/8                          | 20K x 1                   | 20K x 2    | 20K x 5    | 200K x 10  | 200K x 20  | 200K x 50  |
| 04               | 2                              | 20K x 1                   | 20K x 2    | 20K x 5    | 200K x 10  | 200K x 20  | 200K x 50  |
| 05               | 2-1/8                          | 20K x 1                   | 20K x 2    | 20K x 5    | 200K x 10  | 200K x 20  | 200K x 50  |
| 06               | 2-1/4                          | 20K x 1                   | 20K x 2    | 20K x 5    | 200K x 10  | 200K x 20  | 200K x 50  |
| 07               | 2-1/4D                         | 20K x 1                   | 20K x 2    | 20K x 5    | 200K x 10  | 200K x 20  | 200K x 50  |
| 08               | 2-1/4D-P                       | 200K x 10                 | 200K x 20  | 200K x 50  | 200K x 100 | 200K x 200 | 200K x 500 |
| 09               | 2-1/2                          | 20K x 1                   | 20K x 2    | 20K x 5    | 200K x 10  | 200K x 20  | 200K x 50  |
| 10               | 3-1/8                          | 200K x 10                 | 200K x 20  | 200K x 50  | 200K x 100 | 200K x 200 | 200K x 500 |
| 11               | 4                              | 200K x 10                 | 200K x 20  | 200K x 50  | 200K x 100 | 200K x 200 | 200K x 500 |
| 12               | CC20/CC30                      | 20K x 1                   | 20K x 2    | 20K x 5    | 200K x 10  | 200K x 20  | 200K x 50  |
| 13               | Alley Weigh                    | 2K x 0.1                  | 2K x 0.2   | 2K x 0.5   | 20K x 1    | 20K x 2    | 20K x 5    |
| 14               | CC30-3                         | 20K x 1                   | 20K x 2    | 20K x 5    | 200K x 10  | 200K x 20  | 200K x 50  |
| 15               | Chute Weigh                    | 20K x 1                   | 20K x 2    | 20K x 5    | 200K x 10  | 200K x 20  | 200K x 50  |
| 16               | CC-50                          | 200K x 10                 | 200K x 20  | 200K x 50  | 200K x 100 | 200K x 200 | 200K x 500 |
| 18               | SPARE                          | 20K x 1                   | 20K x 2    | 20K x 5    | 200K x 10  | 200K x 20  | 200K x 50  |
| 20               | 1-digi                         | 2K x 0.1                  | 2K x 0.2   | 2K x 0.5   | 20K x 1    | 20K x 2    | 20K x 5    |
| 21               | 1 POLY(DIGI)                   | 20K x 1                   | 20K x 2    | 20K x 5    | 200K x 10  | 200K x 20  | 200K x 50  |
| 22               | 1-7/8,2(DIGI)                  | 20K x 1                   | 20K x 2    | 20K x 5    | 200K x 10  | 200K x 20  | 200K x 50  |
| 23               | 2-1/8,2-1/2,2-7/8,3-3/4 (DIGI) | 20K x 1                   | 20K x 2    | 20K x 5    | 200K x 10  | 200K x 20  | 200K x 50  |
| 97               | Custom Setting                 | 200 x 0.01                | 200 x 0.02 | 200 x 0.05 | 2K x 0.1   | 2K x 0.2   | 2K x 0.5   |
| 98               | Custom Setting                 | 20K x 1                   | 20K x 2    | 20K x 5    | 200K x 10  | 200K x 20  | 200K x 50  |
| 99               | Custom Setting                 | 200K x 100                | 200K x 200 | 200K x 500 |            |            |            |
|                  | 3rd Digit                      | 0                         | 1          | 2          | 3          | 4          | 5          |

Table 9.1 First and Second Values (Calibration Size, Capacity x Increment Size)

The fourth digit of the CCN is found in Table 9.2. For the standard application, choose any of the numbers found in the table. For custom applications, the fourth digit may be used to configure the print format.

**Table 9.2 Table for 4th CCN Digit**

| 4th Digit |
|-----------|
| 0         |
| 1         |
| 2         |
| 3         |
| 4         |
| 5         |
| 6         |
| 7         |
| 8         |
| 9         |

The fifth digit of the CCN is found in Table 9.3.

**Table 9.3 Table for 5th CCN Digit**

| 5th Digit | units |
|-----------|-------|
| 0         | Lb    |
| 1         | Lb    |
| 2         | Lb    |
| 3         | Lb    |
| 4         | Kg    |
| 5         | Kg    |
| 6         | Kg    |
| 7         | Kg    |

### 9.1.5 Adjust Span

Use the **Span Adjust** function to adjust the span value up or down one division at a time. You can adjust the span by up to 10% of capacity.

1. From the **CALIBRATE** menu, select **Span Adjust**.
2. Press the **Up** or **Down Arrow** to adjust the span value by one division.
3. Press **Exit** when finished.

The indicator returns to the previous screen.

### 9.1.6 View Live Weight

---

Select **View Live Weight** to see a live weight display without exiting the menus.



Figure 9.3 Sample Live Weight reading

## 9.2 Scale

---

Select **Scale** from the **Setup Manager** module and the screen in Figure 9.4 appears.



Figure 9.4 Scale screen

Items in this section deal primarily with system configuration. Each is described below.

### 9.2.1 Configure Units

---

Select **Units** from the **SCALE** list and the screen in Figure 9.5 appears.

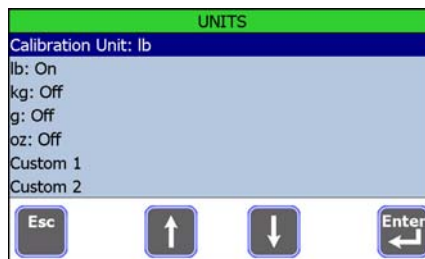

Figure 9.5 Units screen

- **Calibration Unit** Select **Calibration Unit** to pick lb or kg for the calibration unit of measure.
- **lb** Select **lb** to turn **lb** on or off.
- **kg** Select **kg** to turn **kg** on or off.
- **g** Select **g** to turn **g** on or off.
- **oz** Select **oz** to turn **oz** on or off.
- **Custom 1** Select **Custom 1** to create a custom unit of measure. The screen in Figure 9.6 is displayed.



Figure 9.6 CUSTOM unit of measure screen



---

The M3060 indicator supports up to 2 custom units. The instructions are the same regardless of whether you choose Custom 1 or Custom 2.

---

The following example shows how to create “TON” for **Custom 1**.

1. Select **Custom 1** in the **UNITS** screen shown in Figure 9.5.
2. Select **Unit**.
3. Choose **ON**
4. Press the **Enter** key to accept.

The indicator returns to the **CUSTOM** screen.

5. Select **Name**.
6. Key in TON for the custom unit using the alphanumeric entry screen. See [Entering Alphanumeric Values on page 17](#).
7. Press **Enter**

The indicator returns to the **CUSTOM** screen.

8. Select **Cal Weight**.
9. Key in 2000.
10. Press **Enter**.

The indicator returns to the **CUSTOM** screen.

11. Select **Unit Weight**.

12. Key in 1.



---

*Cal Weight is the amount of weight needed to make one custom unit (Unit Weight). In this example, the Cal Weight is 2000 and the Unit Weight is 1 (2000 lbs = 1 ton).*

---

13. From the **Custom 1** screen, press **Esc** twice to return to the **Scale** screen.

### 9.2.2 Settings

---

Select **Settings** from the **Scale** list to configure the following.

**Capacity** Select **Capacity** and enter a value using the keypad that appears. See *Entering Alphanumeric Values* on page 17. Press **Enter** to accept and return to the previous screen. 5000 is the default value.

**Division** Select **Division** and choose a division size from 0.001 to 500. The default division value is 5.

After setting the values, from the **SETTINGS** screen press the **Esc** key to return to the **SCALE** screen.

### 9.2.3 Set Filtering

---

Select **Filter** from the **Scale** list, and the screen in Figure 9.7 appears.

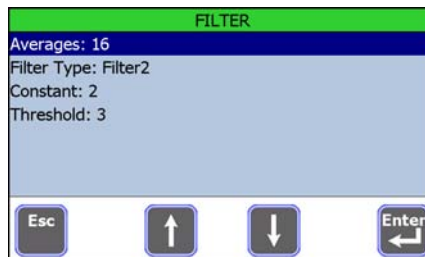

Figure 9.7 FILTER screen

There are four configurable filter items. They are:

**Averages:** Select **Averages** and type in a value for the number of weight readings/second to average for the weight display value. Press **Enter** to accept the displayed value and return to the previous screen. The default value is **16**.

**Filter Type:** Select **Filter Type** and choose from **None**, **Filter1**, or **Filter2**. Press **Enter** to accept and return to the previous screen.

**None** means no filtering.

**Filter1** filtering is slower response to weight in a longer time period with improved accuracy.

**Filter2** filtering is faster response to weight in a short time. This is the default choice.

**Constant:** Select **Constant** if you need to change the default value of **2**. The default will work well in most situations but if you need to increase the stability of the display with a slower response rate, type in a higher value for the **Constant** and press **Enter**. The display returns to the previous screen.

**Threshold:** Select **Threshold** if you need to change the default value of **3**. The default will work well in most situations but if increasing the **Constant** filter setting does not stabilize the display adequately, type in a new, larger value for the Threshold and press **Enter**. The display returns to the previous screen.

After setting the values, from the **FILTER** screen press the **Esc** key to return to the **SCALE** screen.

### 9.2.4 Set Motion/Zero

Select **Motion/Zero** from the **SCALE** list and the screen in Figure 9.8 appears.



Figure 9.8 MOTION/ZERO screen

There are five configurable items. They are:

**Motion Window (Divisions):** Choose **Motion Window** and key in a value for the division size of the motion window. Motion beyond this window causes the motion annunciator to display on the front panel. Press **Enter** to accept and return to the previous screen. Default is 3 divisions.

**Motion Time (Seconds):** Choose **Motion Time** and type in a value for the motion window in seconds. Press **Enter** to accept and return to the previous screen. Default is 1 second.

**AZT Window (Divisions):** Choose **AZT Window** and type in a value for the Auto Zero Tracking window size in number of divisions. Press **Enter** to accept and return to the previous screen. Default is 3 divisions.

**AZT Time (Seconds):** Choose **AZT Time** and type in a value for the motion window in seconds. Press **Enter** to accept and return to the previous screen. Default is 1 second.

**Motion Blanking:** Choose **Motion Blanking** and select **On** or **Off**. If **On**, the screen will display dashes if there is motion on the scale. When the scale is stable the weight will be displayed. Default is **Off**.

After setting the values, from the **Motion/Zero** screen press the **Esc** key to return to the **Scale** screen.

### 9.2.5 Enable / Disable Auto Tare

Depending on your application, the tare function may be available.

1. If tare is available, select **Tare** from the **SCALE** menu.
2. The screen below appears.



Figure 9.9 Tare screen

3. Press **Enter**.
4. Select **On** to turn the **Auto Tare Clear** enable automatic tare clearing or **Off** to disable automatic tare clearing. Default setting is off.

The indicator returns to the previous screen.

5. From the **Tare** screen, press the **Esc** key to return to the **Scale** screen.

## 9.2.6 Set Ranges

Select **Ranges** from the **SCALE** list and the screen in Figure 9.10 appears.



Figure 9.10 Ranges screen

Select from the items shown and use the alphanumeric keypad that appears to enter a value for the item, except for **Center of Zero** which shows two choices. Press **Enter** to accept and return to the screen in Figure 9.10.

- OverLoad:** Select **OverLoad** and you can select **OverLoad Basis:** to select between **Percentage** or **Divisions**. Then select the value at which overloads are recorded. The default is 105% of capacity.
- UnderLoad:** Select **UnderLoad** and you can select **UnderLoad Basis:** to select between **Percentage** or **Divisions**. Then select the value at which underloads are recorded. The default is 20% of capacity below the zero point.
- Zero Range%:** Set **Zero Range%:** to a percentage of capacity which can be zeroed with the **Zero** key. The default is 100% of capacity.
- Center of Zero (Divisions):** Set **Center of Zero** to 0.25 or 0.5 divisions for the center of zero window. Any weight which falls within  $\pm$  your choice of the zero point will cause the display to show the center of zero annunciator, **>0<**, on the screen. The default is 0.25 divisions.
- Auto Print%:** Set **Auto Print%** to a percentage of capacity. The displayed weight must fall below this percentage of capacity before the next autoprint command is carried out. The default value is 0 which disables the function.

After setting the values, from the **RANGES** screen press the **Esc** key to return to the **Scale** screen.

## 9.3 Communications

---

Select **Communications** from the **Setup Manager** list and the screen showing available communications settings appears.

There are settings under each of these communication items. The entire list of settings is given below in alphabetical order along with explanations. You will only see those items which apply to the choice you make from the list. Use this section as a glossary to find an item's explanation.



---

*Always check with the end user network administrator for correct Ethernet and WiFi configurations.*

*The Ethernet supports a 10MB connection.*

---

### 9.3.1 Communication Settings Glossary

---

#### **COM 1, 2, 3**

These items are available for COM 1, 2, 3.

#### **Baud (COM 1, 2, 3)**

Select **Baud** and your choices of baud rate are from **300** to **115200**. The default value is **9600**. Select one and press the **Enter** key to activate it and return to the previous screen.

#### **Data Bits (COM 1, 2, 3)**

Select **Data Bits** and your choices are **7** or **8**. The default value is **8**. Select one and press the **Enter** key to activate it and return to the previous screen.

#### **Handshake (COM 1, 2 3)**

Select **Handshake** and your choices are **Hardware**, **XOnXOff**, or **None**. The default value is **None**. Select one and press the **Enter** key to activate it and return to the previous screen.

#### **Parity (COM 1, 2, 3)**

Select **Parity** and your choices are **None**, **Odd**, or **Even**. The default value is **None**. Select one and press the **Enter** key to activate it and return to the previous screen.

#### **Power (COM 1, 2, 3)**

Select **Power** to toggle power connection of +5 VDC through the serial port on or off.

#### **Stop Bits (COM 1, 2, 3)**

Select **Stop Bits** and your choices are **1** or **2**. The default value is **1**. Select one and press the **Enter** key to activate it and return to the previous screen.

## Ethernet and WiFi

These items are available for Ethernet and WiFi.

### **Client/Server (Ethernet, WiFi)**

Select **Client/Server** to enable the indicator as a **Client** or **Server** or to **Disable** this item. Press the **Enter** key to accept the highlighted item.

### **DHCP (Ethernet, WiFi)**

Select **DHCP** and you are allowed to disable or enable the DHCP. Press **Enter** to save your choice. The default state is **Disabled**.

DHCP (Dynamic Host Configuration Protocol) is a protocol for assigning dynamic IP addresses to devices on a network. If you enable DHCP, the IP address for the indicator is not required.

### **DNS Address (Ethernet, WiFi)**

Select **DNS Address** and the alphanumeric screen appears. Key in the DNS address and press the **Enter** key to accept.

### **Gateway (Ethernet, WiFi)**

Select **Gateway** and the alphanumeric screen appears. Key in the Gateway value and press the **Enter** key to accept.

### **Host Address (Ethernet, WiFi)**

Select **Host Address** and the alphanumeric screen appears. Key in the Host Address and press the **Enter** key to accept.

### **Host Port (Ethernet, WiFi)**

Select **Host Port** and the alphanumeric screen appears. Key in the Host Port value and press the **Enter** key to accept.

### **IP Address (Ethernet, WiFi)**

Select **IP Address** and the alphanumeric screen appears. Key in the IP address and press the **Enter** key to accept.

### **Port (Ethernet, WiFi)**

Select **Port** and the alphanumeric screen appears. Key in the Port value and press the **Enter** key to accept.

### **Subnet Mask (Ethernet, WiFi)**

Select **Subnet Mask** and the alphanumeric screen appears. Key in the Subnet Mask value and press the **Enter** key to accept.

## WiFi Only

These items are available for WiFi only.

### **Authentication Mode (WiFi only)**

Select **Authentication Mode** and your choices are **Open** or **Shared**. Highlight your choice and press the **Enter** key to activate it and return to the previous screen.

### **Encryption (WiFi only)**

Select **Encryption** and you are given the choices: **64 Bit** and **128 Bit**. Highlight your choice and press the **Enter** key to accept.

### **Infrastructure Mode (WiFi only)**

Select **Infrastructure Mode** and choose between **Adhoc** or **Infrastructure**. Highlight your choice and press the **Enter** key.

### **Key Index (WiFi only)**

Select **Key Index** and the alphanumeric screen appears. Key in the Key Index value and press the **Enter** key to accept.

### **Network Key (WiFi only)**

Select **Network Key** and the alphanumeric screen appears. Key in the Network Key value and press the **Enter** key to accept. This is only used in the WiFi communication mode.

### **Security Mode (WiFi only)**

Select **Security Mode** and you are given the three choices:

- **Disabled** This disables security mode.
- **WEP** If you choose **WEP** you are given new items to set for security; [Authentication Mode \(WiFi only\)](#), [Encryption \(WiFi only\)](#), [Key Index \(WiFi only\)](#), and [Network Key \(WiFi only\)](#).
- **WPA PSK** If you choose **WPA PSK** you are given a new item to set for security; [Network Key \(WiFi only\)](#).

### **SSID (WiFi only)**

Select **SSID** and the alphanumeric screen appears. Key in the SSID name and press the **Enter** key to accept.

## 9.4 Select Application

Select **Application Selection** from the **Setup Manager** and the following screen appears.

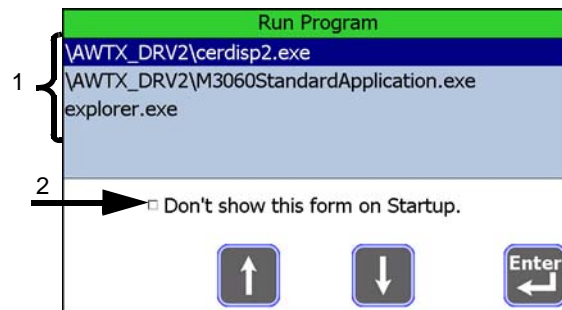

**Figure 9.11 Select Application Screen**

The screen in figure 9.11 shows a sample list of available applications (1) and a checkbox option(2).

1. Select the desired application from the list.
- 2a. Tap the checkbox to place a check in it.

**OR**

- 2b. Leave the checkbox unchecked.



---

*Placing a check in the checkbox will keep this message from displaying on startup. By default, this option is not checked and the customer will see this screen and be prompted to choose the correct application each time the indicator starts up.*

---

3. Press the **Enter** key.

The indicator returns to the previous screen and when you exit the menus and save the changes, the application you chose will be active.

## 9.5 Miscellaneous

---

Select **Miscellaneous** from the **Setup Manager** module and the screen in Figure 9.12 appears.

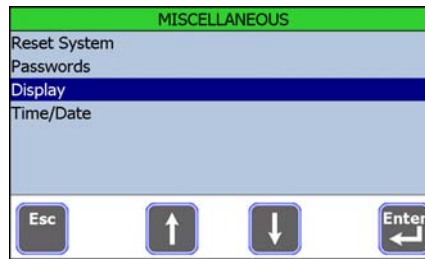

**Figure 9.12 Miscellaneous items**

Following are descriptions of each of these items.

### 9.5.1 Reset System

---

Select **Reset System** and you are given the choice of resetting the following to factory defaults:

- **OverLoad/UnderLoad Counters**
- **Configuration**
- **Calibration**



---

**Resetting the configuration will reset the indicator to factory defaults and all data, including application specific information, will be lost.**

---

## 9.5.2 Reset Passwords





---

**CAUTION:** Changing the Admin password is not recommended as you will not be able to access the menus if it is lost or forgotten.

---

1. Select **Passwords** from the **Miscellaneous** screen.

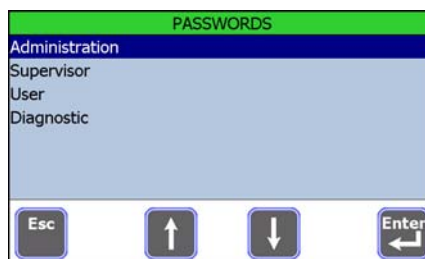
The list of available password categories displays.



**Figure 9.13 Password Categories**

2. Select the password you want to change from the list.

The alphanumeric keypad appears.

3. Key in the new password and press **Enter**.
4. Key in the new password again to verify and press **Enter**.

The indicator returns to the previous screen.

to change the **Admin Password**, the **Supervisor Password**, the **User Password** or the **Diagnostic Password**. The alphanumeric keypad appears. Type in a new numeric password and press the **Enter** key to accept it.



---

*If one password is created for multiple menus, only the highest available level will be accessed. For example, if you set the ADMIN and SUPERVISOR passwords to 1234, only the ADMIN level will be accessed when the password is used.*

---

## 9.5.3 Set Display Properties

In the **DISPLAY** screen, you can change the rate at which the scale updates or change how decimals are shown on screen.

### Change Scale Update Rate

1. From the **Miscellaneous** screen, select **Display**.

The following screen appears.

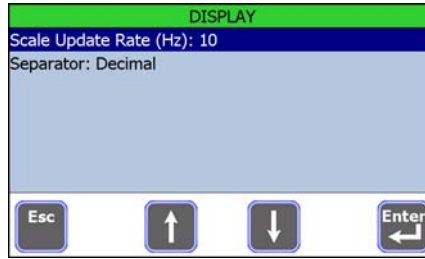

Figure 9.14 Display Update Options

2. Choose the **Scale Update Rate** to change the frequency that the scale updates. The default value is 10.

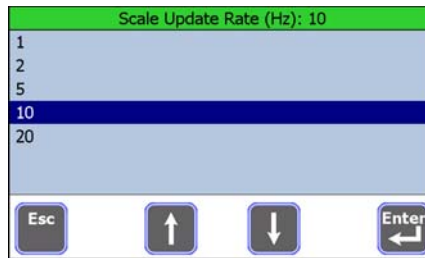

Figure 9.15 Available Scale Update Rates

3. Press **Enter**.

The indicator returns to the previous screen.

### Change Decimal Marker

1. From the **Miscellaneous** screen, select **Display**.
2. Select **Separator: Decimal**.
3. Select either **Decimal** (point) or **Comma** (.). The default option is **Decimal**.
4. Press **Enter**.

The indicator returns to the previous screen.

5. Press **Esc** to return to the **Miscellaneous** screen.

## 9.5.4 Set Time/Date Properties

To change how the time and date appear, select **Time/Date** from the **Miscellaneous** screen.

### Set Time Format

Time can be viewed in 12 hour or 24 hour format.

1. Select **Time Format (Hours)** from the **TIME/DATE** screen.
2. Select either 12 or 24.
3. Press **Enter**.

The indicator returns to the previous screen.

### Set Date Format

Dates can be viewed in the following formats.

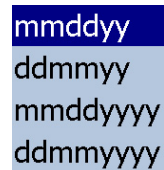

```
mmddyy
ddmmyy
mmddyyyy
ddmmyyyy
```

**Figure 9.16 Available Date Formats**

1. Select **Date Format:** from the **TIME/DATE** screen.
2. Select from the available date formats as shown in figure 9.16.
3. Press **Enter**.

The indicator returns to the previous screen.

4. Repeatedly press the **Esc** key to exit.
5. Select **Yes** to save your changes or **No** to exit without saving.

This completes the **Setup Manager** module chapter.

## 10 Extras

### 10.1 Installing the Compact Flash Cards

---

There are slots on the sides of the M3060 to receive the Compact Flash radio and memory cards. The slot on the left side (when facing the indicator) should only be used for the radio module as shown in the series of photos in Figure 10.1.



**Figure 10.1** Installing the Compact Flash radio

The Compact Flash memory card should be plugged into the slot on the right side of the indicator. This slot has a plunger to help remove an installed card. See Figure 10.2.

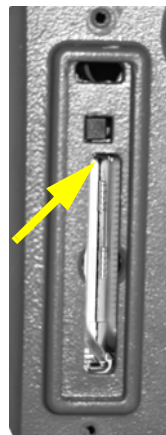

**Figure 10.2** Compact Flash memory slot (arrow shows plunger)

## 10.2 Upgrading Firmware in the M3060

---

If firmware upgrades are made available for the M3060, install them by following these steps:

1. Copy the upgrade file to a Compact Flash memory card or USB thumb drive.
2. Plug the CF card or USB drive into the appropriate slot on the M3060.  
The upgrade begins automatically.
3. Press the **Enter** key when the upgrade file name appears on the screen.
4. Follow the onscreen prompts after the file transfer is done to finish initializing the system for the new firmware.

## 10.3 Updating the M3060 Operating System

---

On occasion, it may be necessary to update or reinstall the operating system in the M3060.



---

**CAUTION:** *When you update the operating system, all data will be lost. Back up all data and your application BEFORE starting the update.*

---

Before you begin, you will need the following:

- A PC with a copy of the M3060 Update Application installed
- An available COM (RS232) port or suitable USB to serial adapter
- A null modem cable
- An ethernet crossover cable

If your computer is on a network, check with your network administrator before updating the M3060. To avoid possible network problems, disconnect your PC from the network until the update is complete.

1. Power off the M3060 and disconnect from the power source.
2. Power off the computer.
3. Connect COM 1 of the M3060 indicator to an open COM (RS232) port on your PC using a null modem cable (not supplied).
4. Connect the ethernet port of the M3060 to an available network connection on the PC using the crossover cable.



---

*If your PC is connected to a multi-port hub, use a standard ethernet cable and connect to an open port on the hub.*

---

5. Power on the PC.

- Start the M3060 Update Application on the PC.

The following screen appears.

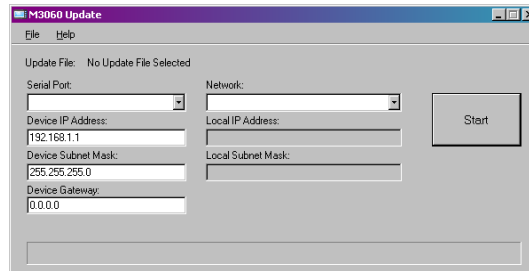

**Figure 10.3 M3060 Update Application**

- Select the COM port that is connected to the M3060 from the **Serial Port** dropdown menu.
- Select the network adapter that is connected to the M3060 from the **Network** dropdown menu.

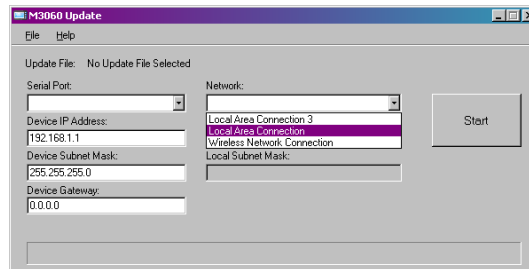

**Figure 10.4 M3060 Update Application Network Selection**



---

*Since the indicator is powered off, the boxes for Device IP Address and Device Subnet Mask will not be filled in.*

---

- Enter appropriate values for the **Device IP Address**, **Device Subnet Mask** and **Device Gateway**. If you are unsure of which values are appropriate, check with your network administrator.
- Click on the File menu and choose **Select Update File**.
- Navigate to the update file for the M3060 indicator.
- Select the update file.
- Click on the **Start** button.

14. Power on the M3060 immediately after clicking on the **Start** button in the application.

The update runs and the operating system is updated. The indicator may turn off during the update process. If it does, turn the indicator back on to complete the update. If you see any errors during the update, check all connections and restart the update.



---

*If you have trouble updating the indicator, set the speed and duplex mode of the network adapter you are using to "10MB Full" or "10 Full Mode". Check with your network administrator on how to do this.*

---

## 10.4 SMA Protocol Table

| Table 3: SMA protocol     |  |
|---------------------------|--|
| Command Sent to Indicator | Result   |
| <LF>W<CR>                 | Weight returned if no motion. Dashes displayed if motion on scale.   |
| <LF>P<CR>                 | Weight returned if no motion. Dashes displayed if motion on scale.   |
| <LF>Z<CR>                 | Scale zeros itself if no motion. Dashes displayed if motion on scale.  |
| <LF>T<CR>                 | Scale tares itself and returns G or N weight if no motion. Dashes displayed if motion on scale.  |
| <LF>T<xxxxxx.xxx><CR>     | Scale attempts to take the <xxxxxx.xxx> data as the tare weight and returns G or N weight if no motion. Dashes displayed if motion on scale.                           |
| <LF>M<CR>                 | Returns the tare weight if no motion. Dashes displayed if motion on scale.   |
| <LF>C<CR>                 | Clears the tare weight if no motion. Dashes displayed if motion on scale.  |
| <LF>U<uuu><CR>            | Sets the unit of measure label to uuu Example: lb_ ( _ =space) Works for lb or kg only, not custom units   |
| <LF>D<CR>                 | Runs scale diagnostics and sends diagnostic message  |
| <LF>A<CR>                 | Sends the SMA compliance level. See note at left.  |
| <LF>B<CR>                 | 1st B sent returns manufacturer<br>2nd B sent returns model software #<br>3rd B sent returns the software revision level<br>4th B sends an END<br>5th or more sends a? |
| <LF>U<CR>                 | Toggles the units of measure if no motion. Dashes displayed if motion on scale.  |
| <LF>I<CR>                 | Sends the SMA compliance level as <i>SMA:compliance level / revision level</i>   |

| Table 3: SMA protocol                                    |   |
|--|---|
| Command Sent to Indicator                                | Result  |
| <LF>N<CR>  | <p>1st N sends the scale type; <b>S</b> or <b>C</b>.<br/> <b>TYP:S</b> = scale, <b>TYP:C</b> = Classifier</p> <p>2nd N sends <b>CAP:uuu:c.c:n:d</b> where<br/> <b>uuu</b> = unit of measure<br/> <b>c.c</b> = full capacity of this range. If multi-interval is not enabled, this is the scale capacity.<br/> <b>n</b> = Least significant count-by digit<br/> <b>d</b> = decimal point position:<br/> 0 = none<br/> 1 = XXXX.X<br/> 2 = XXX.XX<br/> 3 = XX.XXX...etc.</p> <p>3rd N sends the following if multi-interval is enabled: the same info as the 2nd N except for the upper range of the multi-interval.</p> <p>3rd N sends the following if the multi-interval is disabled: List of the SMA level 2 commands that are implemented:<br/> <b>CMD:PTMCU</b></p> <p>Last valid N sends <b>END</b><br/> Subsequent N commands will return a '?' response.</p> |
| ESC  | This reboots the indicator  |
| <LF>YZ<CR>   | Out database dump   |
| <LF>XT<cutoff><xxxx.xx><CR><br>Set a cutoff/trip weight. | Attempts the take <xxxx.xx> as the weight for cutoff #<cutoff>. The indicator will respond with: <LF>XT<cutoff><xxxx.xx>Set<CR> if the cutoff weight was accepted or <LF>XTFail<CR> if the cutoff weight could not be set to the value specified. Cutoff =1-3. Weight limited to scale cap.   |
| <LF>XT<cutoff><CR><br>Request a cutoff/trip weight.      | The indicator will respond with: <LF>XT<cutoff><xxxx.xx><CR> where <xxxx.xx> is the weight for cutoff number <cutoff>.<br>or<br><LF>XTError<CR> if the cutoff number specified is invalid. Cutoff =1-3. Weight limited to scale cap.  |



*The A and B commands are related. An A command MUST be sent before the first B command can be sent. Multiple B commands can be sent after the A command and each one will return a different piece of data. If a B command returns a "?" or END response, an A command is needed to reset the B command.*

*The I and N commands are related. An I command MUST be sent before the first N command can be sent. Multiple N commands can be sent after the I command and each one will return a different piece of data. If an N command returns a "?" or END response, an I command is needed to reset the N command.*



# 11 Technical Illustrations

## 11.1 System Block Diagram

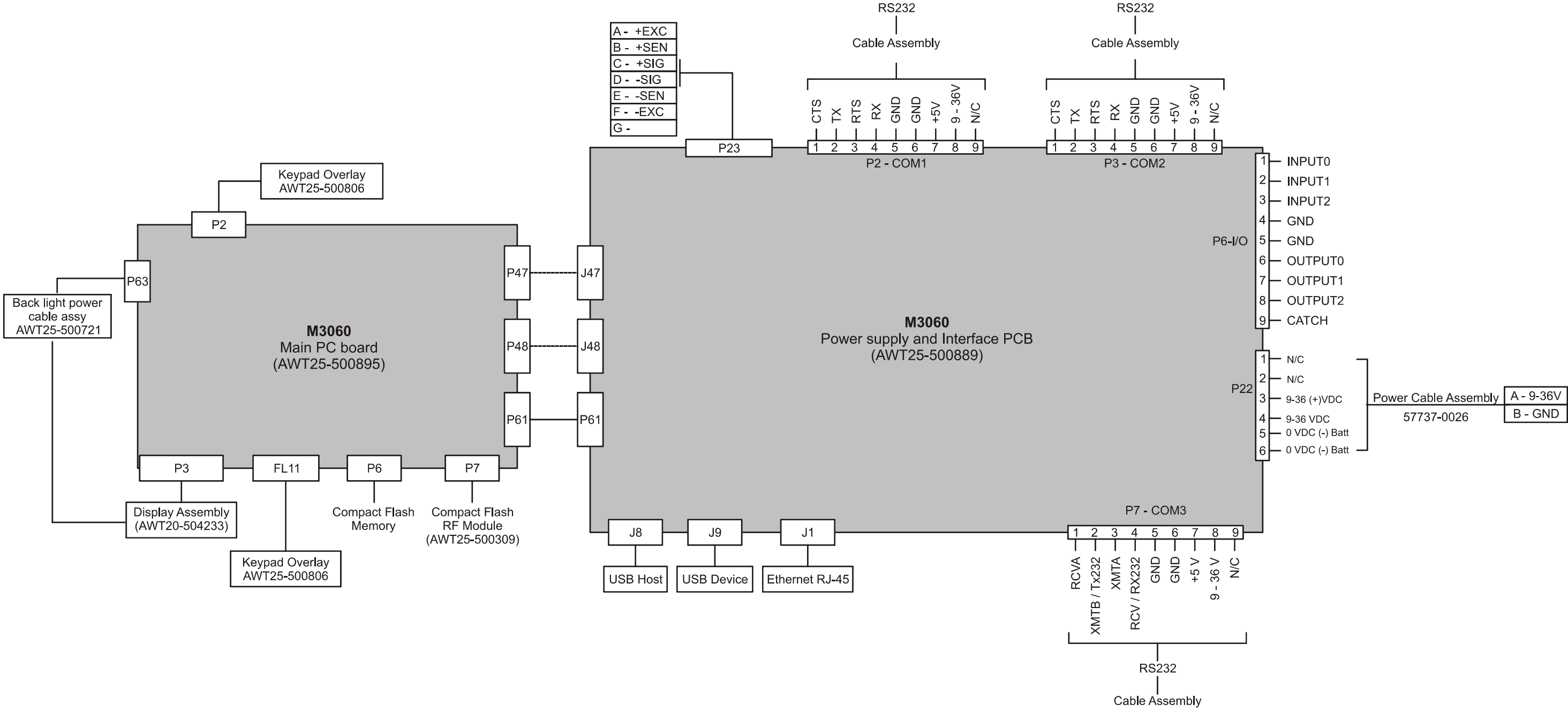

11.2 Exploded View of M3060 (Part number AWT15-500883)

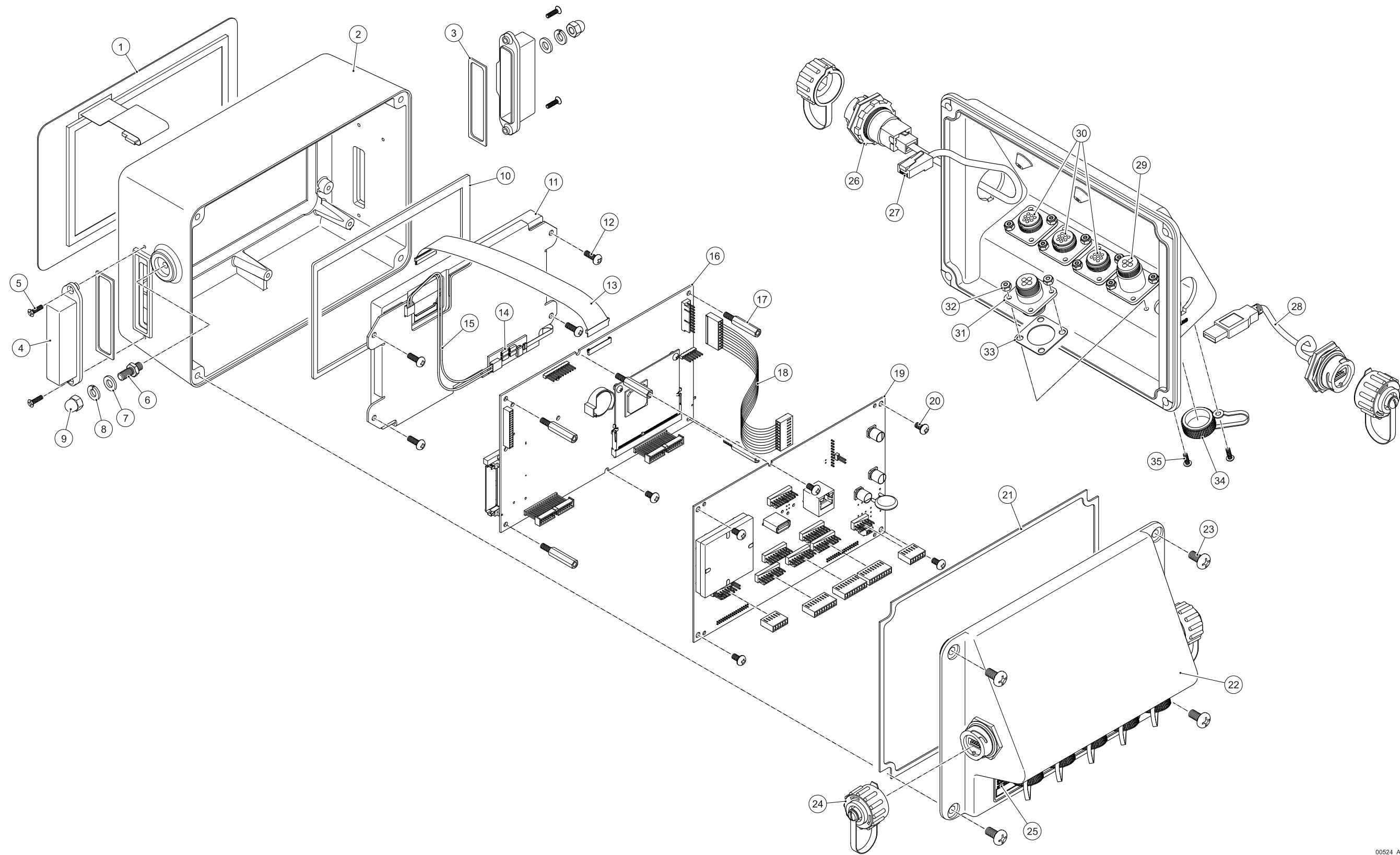

00524\_A

### 11.3 M3060 Indicator Parts List & Options

| Reference Number | Description                                      | Part No.     | Qty  |
|------------------|--|--------------|------|
| 1                | TOUCH PANEL KEYPAD, MOD 3060                     | AWT25-500806 | 1    |
| 2                | ENC, INSTRMNT, MACH-M3060                        | AWT20-504179 | 1    |
| 3                | GASKET, REAR HOUSING                             | AWT20-503767 | 1    |
| 4                | COVER, WIRELESS CARD                             | AWT20-501627 | 2    |
| 5                | SCREW, M3X12 FLAT HEAD PHILLIPS                  | AWT20-501693 | 4    |
| 6                | HEX ADAPTER-M6, MOUNTING                         | AWT20-500483 | 2    |
| 7                | WASHER, FLAT M6 ZINC PLATED CS                   | 52615-0099   | 2    |
| 8                | WASHER, METRIC REG LOCK 6MM                      | 54005-0184   | 2    |
| 9                | NUT, M6  | 54008-0058   | 2    |
| 10               | GASKET, DISPLAY                                  | 58007-0019   | 1    |
| 11               | DISPLAY ASSY, M3060                              | AWT15-500884 | 1    |
| 12               | SCREW, MACH P/HD M4X12MM SST                     | AWT20-504481 | 4    |
| 13               | CABLE ASSY, DISPLAY INTFC 3060                   | AWT25-500720 | 1    |
| 14               | PCB ASSY, BACKLIGHT INTF 3060                    | AWT25-500815 | 1    |
| 36               | TAPE, DOUBLE SIDED GRAY.75 WIDE (not shown)      | 52595-0010   | 0.12 |
| 15               | CABLE ASSY, BACKLIGHT PWR 3060                   | AWT25-500721 | 1    |
| 16               | KIT, MAIN BD/PD CARD ENG 3060                    | AWT15-500895 | 1    |
| 17               | STANDOFF HEX M4x25mm M/F SST                     | AWT20-504189 | 5    |
| 18               | Cable Assy, Power                                | AWT25-500157 | 1    |
| 19               | PCB ASSY, PWR SPLY & INTFC 3060                  | AWT25-500889 | 1    |
| 20               | SCREW, MACH P/HD M4X8MM SST                      | 60084-1035   | 6    |
| 21               | GASKET, REAR HOUSING                             | AWT20-503767 | 1    |
| 22               | HOUSING, REAR M3060                              | AWT20-503770 | 1    |
| 23               | SCREW, (M6X1 12MM LG) SST P/HD                   | 46573-0059   | 4    |
| 24               | DUST COVER, RJ45/USB INDL CONN                   | AWT25-500848 | 2    |
| 25               | LABEL, CERT., M3060                              | AWT20-504257 | 1    |
| 26               | CONN RJ45 INDL ETHERNET PNL MT                   | AWT25-500847 | 1    |
| 27               | CABLE ASSY, RJ45 TO RJ45 1' BLK                  | AWT25-500850 | 1    |
| 28               | CORD ASSY USB-A PLUG AND RCPT                    | AWT25-500846 | 1    |
| 29               | HARNESS, WIRE POWER AMP                          | AWT25-500913 | 1    |
|                  | AUTOMOTIVE ATC 5AMP BLADE FUSE (part of item 29) | AWT25-500994 | 1    |
| 30               | HARNESS, RS232/8P MOD2015                        | 51030-0015   | 3    |
| 31               | HARNESS, PCB/J-BOX (M640)                        | 50044-0037   | 1    |
| 32               | NUT, HEX LOCKING SS 4-40UNJC-3B                  |              |      |
| 33               | GASKET, SYN RUBBER-CIR CONN 12S                  |              |      |
| 34               | CAP, PLASTIC W/STRAP .297 DIA                    |              |      |
| 35               | SCREW, PHIL PAN HD SS 4-40X.375                  |              |      |
| 36               | (not shown) TAPE, DOUBLE SIDED GRAY.75 WIDE      |              |      |
| Extras           |  |              |      |
|                  | ADH(INST), CYANOACRYLATE-BLACK                   |              |      |
|                  | ADHESIVE/SEALANT 242 BLUE 10ml                   |              |      |
|                  | COMPOUND, CRSN PVNT-.5 PT CAN                    |              |      |

Refer to the following menu maps to help you through the various menus. Click on the blue text to jump to the corresponding section in the manual for more information.

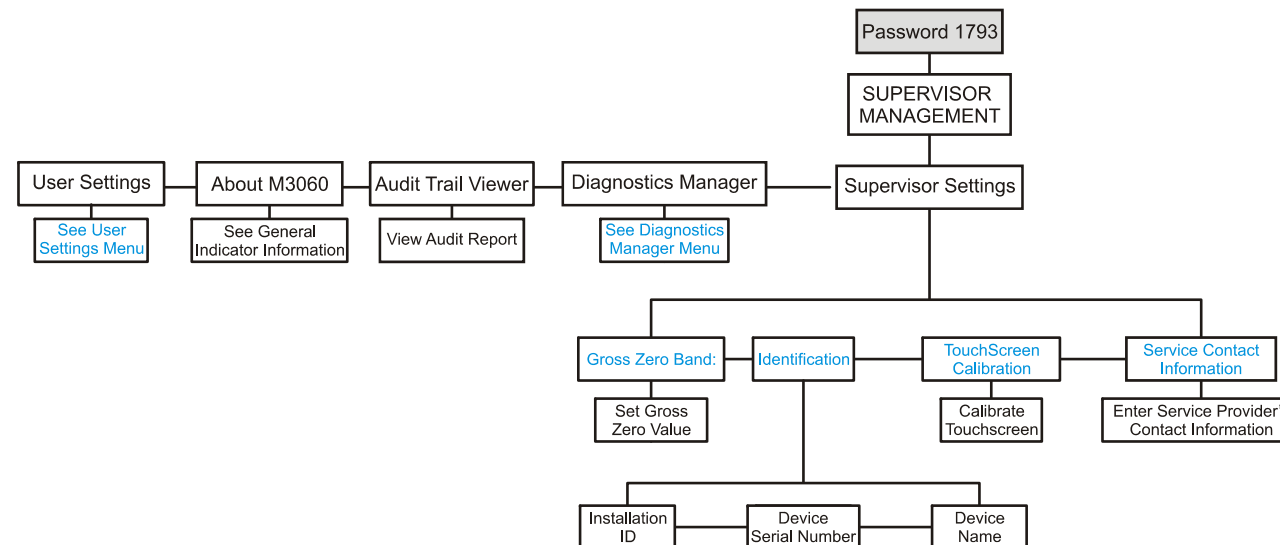
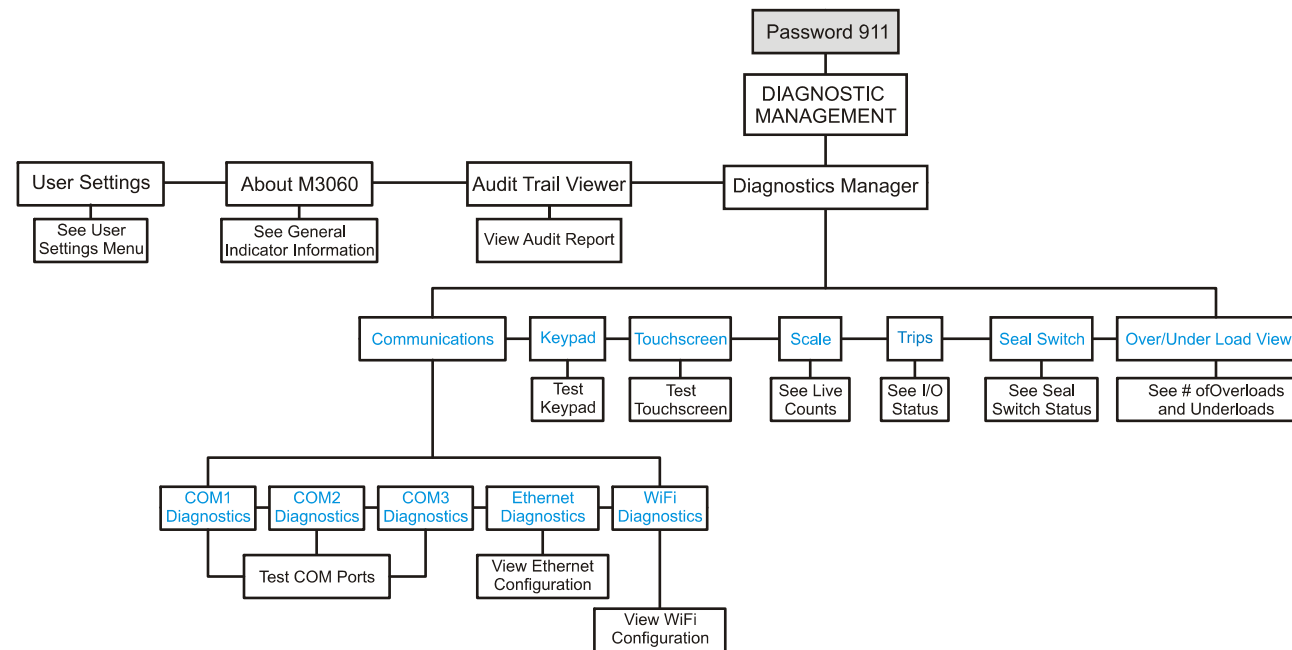
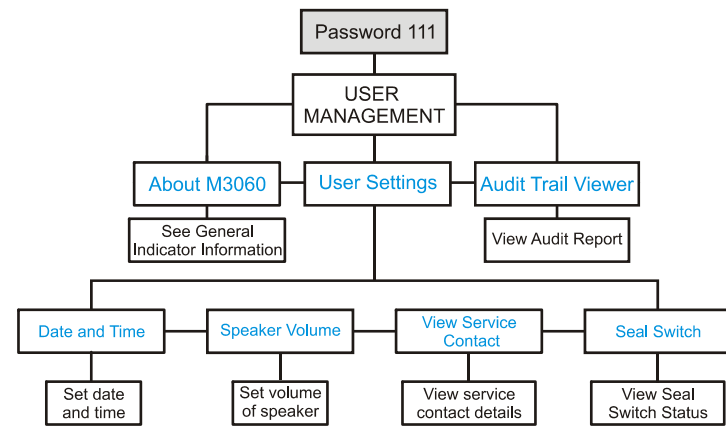

The next page shows the Admin. Menu and the various sub-menus contained in it.

Due to the length of the Admin Menu, the larger submenus have been split off from the main menu.

11.4.1 Administration Management Menu

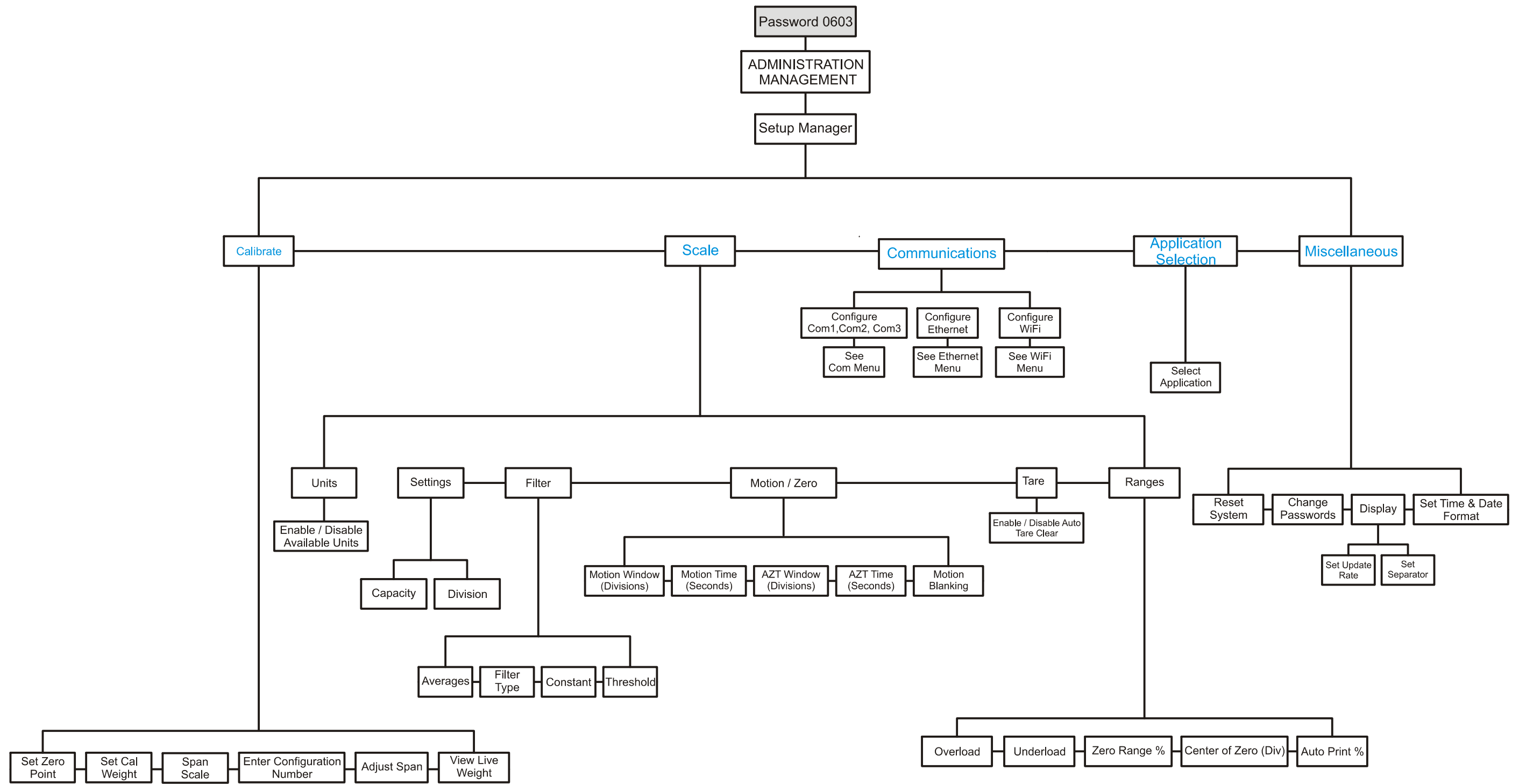

See additional communications sub-menus on the following page.

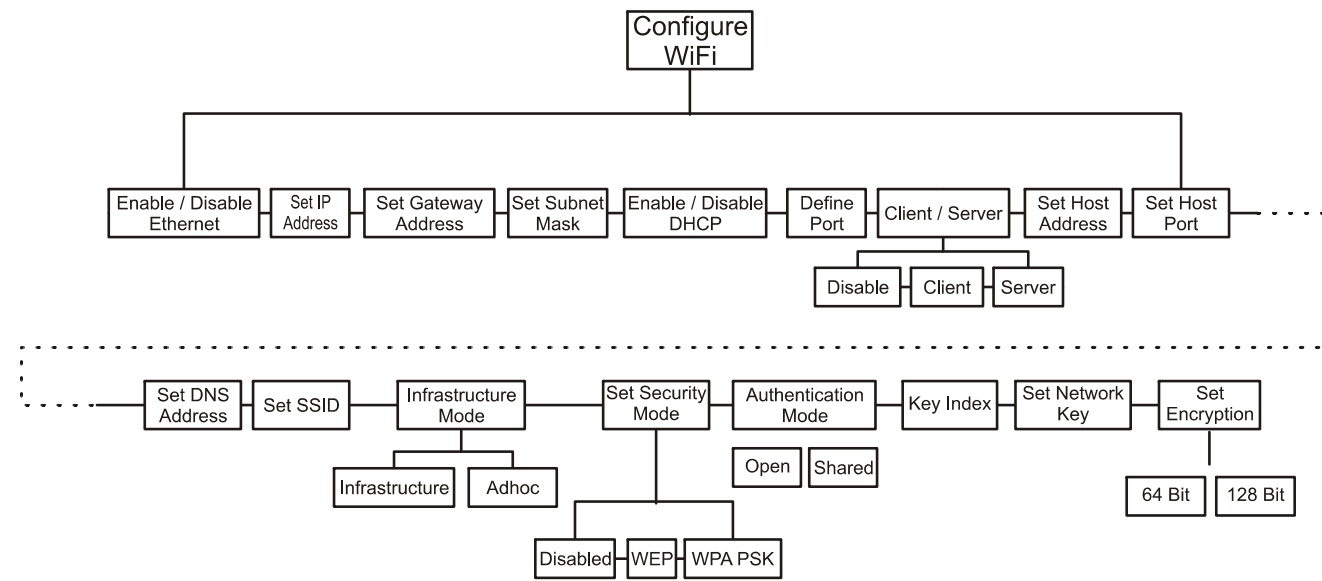
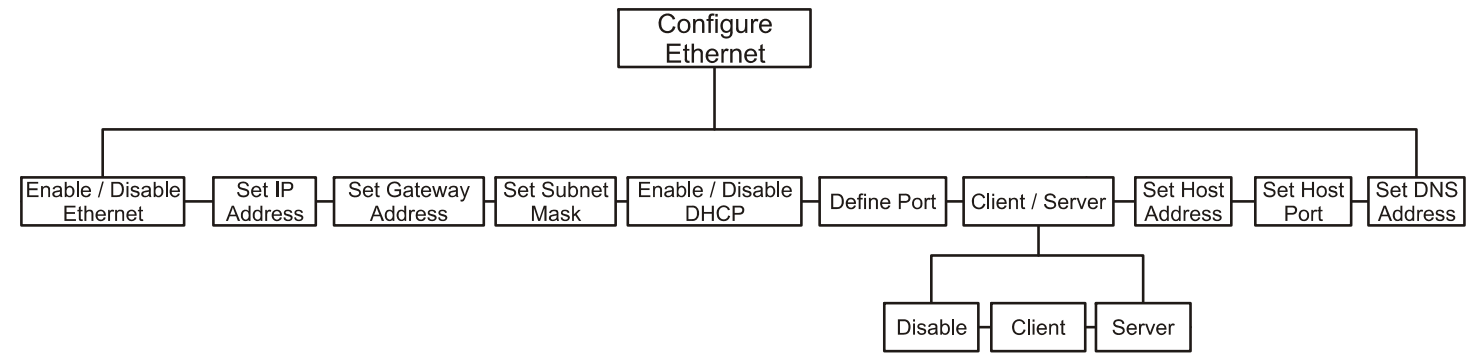
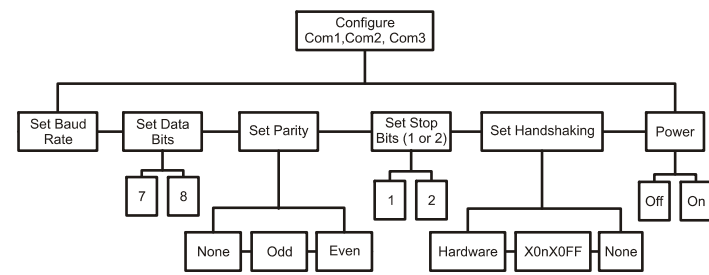



**Standard Scale & Supply Company**  
**25421 Glendale Avenue**  
**Redford, MI 48239**  
**313-255-6700**  
**[www.standardscale.com](http://www.standardscale.com)**

